

## Schema fsvStrict035.xsd

schema location: <C:\Kunder\OIO-forbrugsafregning\namespace\fsvStrict035.xsd>  
targetNamespace: <http://rep.oio.dk/ubl/xml/schemas/0p71/extensible/businessdomain/utilities/2005/10/11/>

### Elements

[AccountCode](#)  
[AdditionalDescription](#)  
[AdditionalSpecification](#)  
[AddressID](#)  
[AddressLines](#)  
[Amount](#)  
[AverageAmount](#)  
[Balance](#)  
[BasePrice](#)  
[BuyerParty](#)  
[CategoryTotal](#)  
[CityName](#)  
[Code](#)  
[Comment](#)  
[ConsumptionAverage](#)  
[ConsumptionPoint](#)  
[ConsumptionPointAddress](#)  
[ConsumptionPointID](#)  
[ConsumptionType](#)  
[Contract](#)  
[ContractID](#)  
[Country](#)  
[CurrentChargeType](#)  
[Customer](#)  
[DeliveredQuantity](#)  
[DeliveredQuantityBasedOnMeterReadings](#)  
[DeliveryAddress](#)  
[DeliveryDate](#)  
[DeliveryMeterInformation](#)  
[DeliveryOnAccountPaymentSchedule](#)  
[DeliveryTaxInformation](#)  
[Description](#)  
[DescriptionCode](#)  
[Descriptions](#)  
[DevelopmentInConsumption](#)  
[Discount](#)  
[District](#)  
[DuePaymentDate](#)  
[EndDate](#)  
[EnergyTaxInformation](#)  
[EnergyTaxInformationDetail](#)  
[FSV](#)  
[HouseNumber](#)  
[ID](#)  
[InstallationAddress](#)  
[InstallationID](#)  
[InvoicedPeriod](#)  
[InvoicedQuantity](#)  
[Item](#)  
[ItemAddress](#)  
[LatestMeterReadingDate](#)  
[LatestMeterStand](#)  
[Line](#)  
[LineExtensionAmount](#)  
[LineExtensionAmountBeforeDiscount](#)  
[LineExtensionTotalAmount](#)  
[LineID](#)  
[MainSubscriberID](#)  
[MeterConstant](#)  
[MeteringPoint](#)

### Complex types

[AdditionalSpecificationType](#)  
[AddressLinesType](#)  
[AmountType](#)  
[BasePriceType](#)  
[BuyerPartyType](#)  
[CategoryTotalType](#)  
[ConsumptionAverageType](#)  
[ConsumptionPointAddressType](#)  
[ConsumptionPointType](#)  
[ContractType](#)  
[CountryType](#)  
[CustomerType](#)  
[DeliveredQuantityBasedOnMeterReadingsType](#)  
[DeliveryAddressType](#)  
[DeliveryMeterInformationType](#)  
[DeliveryOnAccountPaymentScheduleType](#)  
[DeliveryTaxInformationType](#)  
[DescriptionsType](#)  
[DevelopmentInConsumptionType](#)  
[DiscountType](#)  
[EnergyTaxInformationDetailType](#)  
[EnergyTaxInformationType](#)  
[FSVType](#)  
[InstallationAddressType](#)  
[InvoicedPeriodType](#)  
[ItemAddressType](#)  
[ItemType](#)  
[MainSubscriberIDType](#)  
[MeteringPointType](#)  
[MeterReadingType](#)  
[MeterSpecificationType](#)  
[OnAccountMainInformationType](#)  
[OnAccountMainTextType](#)  
[OnAccountPaymentsTextType](#)  
[OnAccountPaymentsType](#)  
[PartyIdentificationType](#)  
[PartyNameType](#)  
[PeriodType](#)  
[QuantityType](#)  
[ServiceChargeType](#)  
[SupplierType](#)  
[TaxAmountsType](#)  
[TaxCategoryType](#)  
[UtilityInvoiceMainPeriodType](#)  
[UtilityInvoiceType](#)  
[UtilityLegalTotalsType](#)  
[UtilitySubInvoiceDetailsType](#)  
[UtilitySubInvoiceHeaderType](#)  
[UtilitySubInvoiceLineType](#)  
[UtilitySubInvoiceSpecificationType](#)  
[UtilitySubInvoiceTotalsType](#)  
[UtilitySubLegalTotalsType](#)  
[UtilitySubTaxTotalType](#)  
[UtilityTaxTotalType](#)

[MeterNumber](#)  
[MeterReading](#)  
[MeterReadingComments](#)  
[MeterReadingMethod](#)  
[MeterSpecification](#)  
[Name](#)  
[OioLineRefID](#)  
[OnAccount](#)  
[OnAccountMainInformation](#)  
[OnAccountMainText](#)  
[OnAccountPayments](#)  
[OnAccountPaymentsText](#)  
[OneTimeChargeType](#)  
[PackQuantity](#)  
[PartyID](#)  
[PartyIdentification](#)  
[PartyName](#)  
[Period](#)  
[PeriodOfConsumption](#)  
[PostalZone](#)  
[PreviousMeterReadingDate](#)  
[PreviousMeterStand](#)  
[PriceAmount](#)  
[Quantity](#)  
[RateCategoryCodeID](#)  
[RatePercentNumeric](#)  
[RefID](#)  
[ServiceAmount](#)  
[ServiceCharge](#)  
[ServiceID](#)  
[ServiceIndicator](#)  
[ServiceReasonCode](#)  
[StartDate](#)  
[Street](#)  
[SubscriberID](#)  
[SubType](#)  
[Supplier](#)  
[TaxableAmount](#)  
[TaxAmount](#)  
[TaxAmounts](#)  
[TaxCategory](#)  
[TaxEnergyAmount](#)  
[TaxEnergyBalanceAmount](#)  
[TaxEnergyOnAccountAmount](#)  
[TaxExclusiveTotalAmount](#)  
[TaxInclusiveTotalAmount](#)  
[TaxTotalAmount](#)  
[TaxTypeCode](#)  
[Text](#)  
[ToBePaidTotalAmount](#)  
[TotalDeliveredQuantity](#)  
[Type](#)  
[UtilityInvoice](#)

[UtilityInvoiceCategoryCode](#)

[UtilityInvoiceID](#)

[UtilityInvoiceMainPeriod](#)

[UtilityLegalTotals](#)

[UtilitySubInvoiceDetails](#)

[UtilitySubInvoiceHeader](#)

[UtilitySubInvoiceLine](#)

[UtilitySubInvoiceSpecification](#)

[UtilitySubInvoiceTotals](#)

[UtilitySubLegalTotals](#)

[UtilitySubTaxTotal](#)

[UtilitySubTotalAmount](#)

[UtilityTaxTotal](#)

## element **AccountCode**

diagram



namespace <http://rep.oio.dk/ubl/xml/schemas/0p71/extensible/businessdomain/utilities/2005/10/11/>

type **xsd:string**

properties content simple

used by complexType [BuyerPartyType](#)

source `<xsd:element name="AccountCode" type="xsd:string"/>`

## element **AdditionalDescription**

diagram



namespace <http://rep.oio.dk/ubl/xml/schemas/0p71/extensible/businessdomain/utilities/2005/10/11/>

type **xsd:string**

properties content simple

used by complexType [AdditionalSpecificationType](#)

source `<xsd:element name="AdditionalDescription" type="xsd:string"/>`

## element **AdditionalSpecification**

diagram

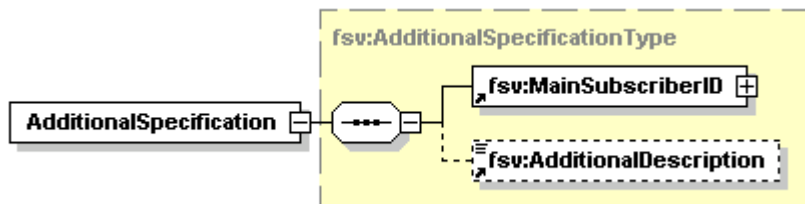

namespace <http://rep.oio.dk/ubl/xml/schemas/0p71/extensible/businessdomain/utilities/2005/10/11/>

type [fsv:AdditionalSpecificationType](#)

properties content complex

children [fsv:MainSubscriberID](#) [fsv:AdditionalDescription](#)

used by complexType [ConsumptionPointType](#)

source `<xsd:element name="AdditionalSpecification" type="fsv:AdditionalSpecificationType"/>`

## element AddressID

diagram

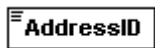

namespace <http://rep.oio.dk/ubl/xml/schemas/0p71/extensible/businessdomain/utilities/2005/10/11/>

type **xsd:string**

properties content simple

used by complexType [DeliveryAddressType](#)

source `<xsd:element name="AddressID" type="xsd:string"/>`

## element AddressLines

diagram

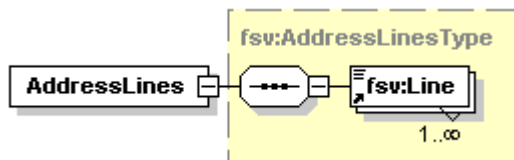

namespace <http://rep.oio.dk/ubl/xml/schemas/0p71/extensible/businessdomain/utilities/2005/10/11/>

type [fsv:AddressLinesType](#)

properties content complex

children [fsv:Line](#)

used by complexType [DeliveryAddressType](#)

source `<xsd:element name="AddressLines" type="fsv:AddressLinesType"/>`

## element Amount

diagram



namespace <http://rep.oio.dk/ubl/xml/schemas/0p71/extensible/businessdomain/utilities/2005/10/11/>

type [fsv:AmountType](#)

properties content complex

used by complexType [OnAccountPaymentsType](#)

attributes	Name	Type	Use	Default	Fixed	Annotation
	currencyID	<b>xsd:string</b>	optional	DKK		

source `<xsd:element name="Amount" type="fsv:AmountType"/>`

## element AverageAmount

diagram



namespace <http://rep.oio.dk/ubl/xml/schemas/0p71/extensible/businessdomain/utilities/2005/10/11/>

type [fsv:AmountType](#)

properties content complex

used by complexType [ConsumptionAverageType](#)

attributes	Name	Type	Use	Default	Fixed	Annotation
	currencyID	<b>xsd:string</b>	optional	DKK		

source `<xsd:element name="AverageAmount" type="fsv:AmountType"/>`

## element Balance



namespace <http://rep.oio.dk/ubl/xml/schemas/0p71/extensible/businessdomain/utilities/2005/10/11/>

type [fsv:AmountType](#)

properties content complex

used by complexType [DeliveryTaxInformationType](#)

attributes	Name	Type	Use	Default	Fixed	Annotation
	currencyID	<b>xsd:string</b>	optional	DKK		

source `<xsd:element name="Balance" type="fsv:AmountType"/>`

## element BasePrice

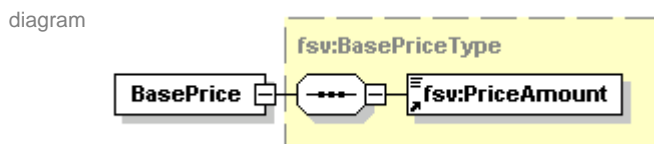

namespace <http://rep.oio.dk/ubl/xml/schemas/0p71/extensible/businessdomain/utilities/2005/10/11/>

type [fsv:BasePriceType](#)

properties content complex

children [fsv:PriceAmount](#)

used by complexType [ItemType](#)

source `<xsd:element name="BasePrice" type="fsv:BasePriceType"/>`

## element BuyerParty

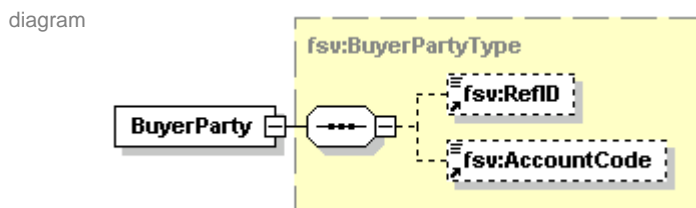

namespace <http://rep.oio.dk/ubl/xml/schemas/0p71/extensible/businessdomain/utilities/2005/10/11/>

type [fsv:BuyerPartyType](#)

properties content complex

children [fsv:RefID](#) [fsv:AccountCode](#)

used by complexType [UtilityInvoiceType](#)

source `<xsd:element name="BuyerParty" type="fsv:BuyerPartyType"/>`

## element **CategoryTotal**

diagram

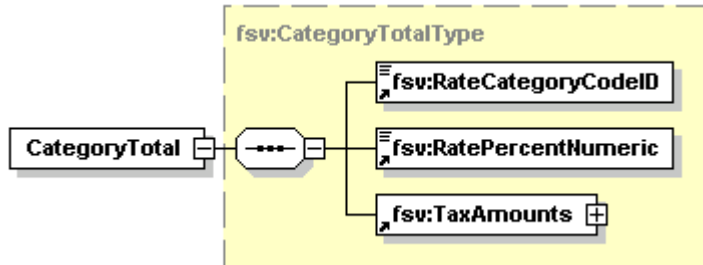

namespace <http://rep.oio.dk/ubl/xml/schemas/0p71/extensible/businessdomain/utilities/2005/10/11/>

type [fsv:CategoryTotalType](#)

properties content complex

children [fsv:RateCategoryCodeID](#) [fsv:RatePercentNumeric](#) [fsv:TaxAmounts](#)

used by complexTypes [UtilitySubTaxTotalType](#) [UtilityTaxTotalType](#)

source `<xsd:element name="CategoryTotal" type="fsv:CategoryTotalType"/>`

## element **CityName**

diagram



namespace <http://rep.oio.dk/ubl/xml/schemas/0p71/extensible/businessdomain/utilities/2005/10/11/>

type `xsd:string`

properties content simple

used by complexTypes [DeliveryAddressType](#) [InstallationAddressType](#) [ItemAddressType](#)

source `<xsd:element name="CityName" type="xsd:string"/>`

## element **Code**

diagram

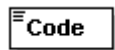

namespace <http://rep.oio.dk/ubl/xml/schemas/0p71/extensible/businessdomain/utilities/2005/10/11/>

type `xsd:string`

properties content simple

used by complexType [CountryType](#)

source `<xsd:element name="Code" type="xsd:string"/>`

## element **Comment**

diagram



namespace <http://rep.oio.dk/ubl/xml/schemas/0p71/extensible/businessdomain/utilities/2005/10/11/>

type `xsd:string`

properties content simple  
 used by complexTypes [ConsumptionPointType](#) [ItemAddressType](#) [ItemType](#) [MainSubscriberIDType](#) [PartyIdentificationType](#)  
 source `<xsd:element name="Comment" type="xsd:string"/>`

### element ConsumptionAverage

diagram

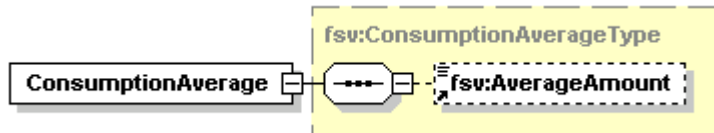

namespace <http://rep.oio.dk/ubl/xml/schemas/0p71/extensible/businessdomain/utilities/2005/10/11/>  
 type [fsv:ConsumptionAverageType](#)  
 properties content complex  
 children [fsv:AverageAmount](#)  
 used by complexType [UtilityInvoiceType](#)  
 source `<xsd:element name="ConsumptionAverage" type="fsv:ConsumptionAverageType"/>`

### element ConsumptionPoint

diagram

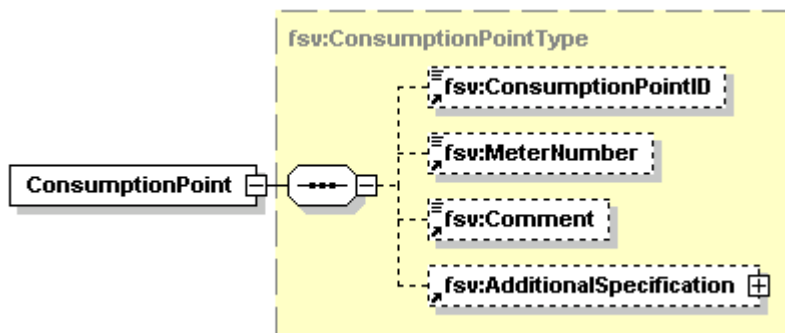

namespace <http://rep.oio.dk/ubl/xml/schemas/0p71/extensible/businessdomain/utilities/2005/10/11/>  
 type [fsv:ConsumptionPointType](#)  
 properties content complex  
 children [fsv:ConsumptionPointID](#) [fsv:MeterNumber](#) [fsv:Comment](#) [fsv:AdditionalSpecification](#)  
 used by complexType [UtilityInvoiceType](#)  
 source `<xsd:element name="ConsumptionPoint" type="fsv:ConsumptionPointType"/>`

### element ConsumptionPointAddress

diagram

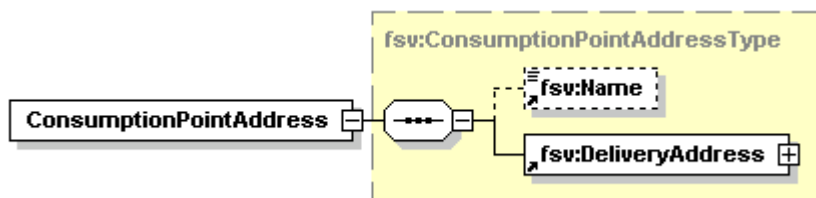

namespace <http://rep.oio.dk/ubl/xml/schemas/0p71/extensible/businessdomain/utilities/2005/10/11/>

type [fsv:ConsumptionPointAddressType](#)  
properties content complex  
children [fsv:Name](#) [fsv:DeliveryAddress](#)  
used by complexType [UtilityInvoiceType](#)  
source `<xsd:element name="ConsumptionPointAddress" type="fsv:ConsumptionPointAddressType"/>`

## element ConsumptionPointID

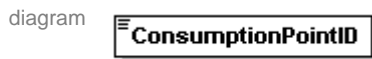

namespace <http://rep.oio.dk/ubl/xml/schemas/0p71/extensible/businessdomain/utilities/2005/10/11/>  
type **xsd:string**  
properties content simple  
used by complexType [ConsumptionPointType](#)  
source `<xsd:element name="ConsumptionPointID" type="xsd:string"/>`

## element ConsumptionType

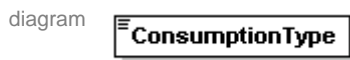

namespace <http://rep.oio.dk/ubl/xml/schemas/0p71/extensible/businessdomain/utilities/2005/10/11/>  
type **xsd:string**  
properties content simple  
used by complexType [ItemType](#)  
source `<xsd:element name="ConsumptionType" type="xsd:string"/>`

## element Contract

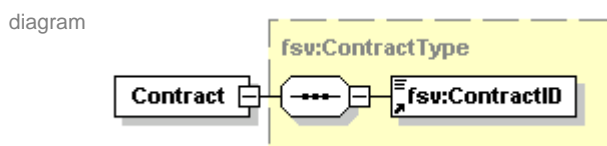

namespace <http://rep.oio.dk/ubl/xml/schemas/0p71/extensible/businessdomain/utilities/2005/10/11/>  
type [fsv:ContractType](#)  
properties content complex  
children [fsv:ContractID](#)  
used by complexType [ItemType](#)  
source `<xsd:element name="Contract" type="fsv:ContractType"/>`

## element ContractID

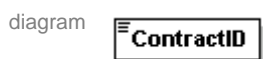

namespace <http://rep.oio.dk/ubl/xml/schemas/0p71/extensible/businessdomain/utilities/2005/10/11/>



type **xsd:string**  
properties content simple  
used by complexType [ContractType](#)  
source `<xsd:element name="ContractID" type="xsd:string"/>`

## element **Country**

diagram

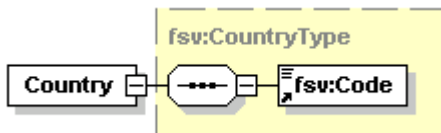

namespace <http://rep.oio.dk/ubl/xml/schemas/0p71/extensible/businessdomain/utilities/2005/10/11/>  
type [fsv:CountryType](#)  
properties content complex  
children [fsv:Code](#)  
used by complexTypes [DeliveryAddressType](#) [InstallationAddressType](#) [ItemAddressType](#)  
source `<xsd:element name="Country" type="fsv:CountryType"/>`

## element **CurrentChargeType**

diagram

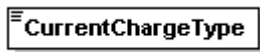

namespace <http://rep.oio.dk/ubl/xml/schemas/0p71/extensible/businessdomain/utilities/2005/10/11/>  
type **xsd:string**  
properties content simple  
used by complexType [ItemType](#)  
source `<xsd:element name="CurrentChargeType" type="xsd:string"/>`

## element **Customer**

diagram

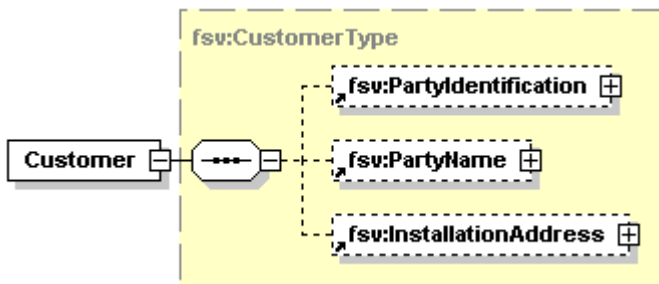

namespace <http://rep.oio.dk/ubl/xml/schemas/0p71/extensible/businessdomain/utilities/2005/10/11/>  
type [fsv:CustomerType](#)  
properties content complex  
children [fsv:PartyIdentification](#) [fsv:PartyName](#) [fsv:InstallationAddress](#)  
used by complexType [UtilitySubInvoiceHeaderType](#)  
source `<xsd:element name="Customer" type="fsv:CustomerType"/>`

### element **DeliveredQuantity**

diagram



namespace <http://rep.oio.dk/ubl/xml/schemas/0p71/extensible/businessdomain/utilities/2005/10/11/>

type [fsv:QuantityType](#)

properties content complex

used by complexType [MeterReadingType](#)

attributes	Name	Type	Use	Default	Fixed	Annotation
	quantityUnitCode	xsd:string	required			

source `<xsd:element name="DeliveredQuantity" type="fsv:QuantityType"/>`

### element **DeliveredQuantityBasedOnMeterReadings**

diagram

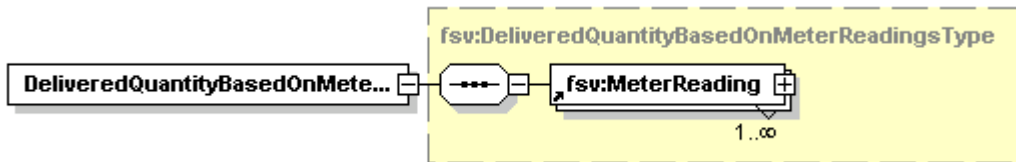

namespace <http://rep.oio.dk/ubl/xml/schemas/0p71/extensible/businessdomain/utilities/2005/10/11/>

type [fsv:DeliveredQuantityBasedOnMeterReadingsType](#)

properties content complex

children [fsv:MeterReading](#)

used by complexType [MeteringPointType](#)

source `<xsd:element name="DeliveredQuantityBasedOnMeterReadings" type="fsv:DeliveredQuantityBasedOnMeterReadingsType"/>`

### element **DeliveryAddress**

diagram

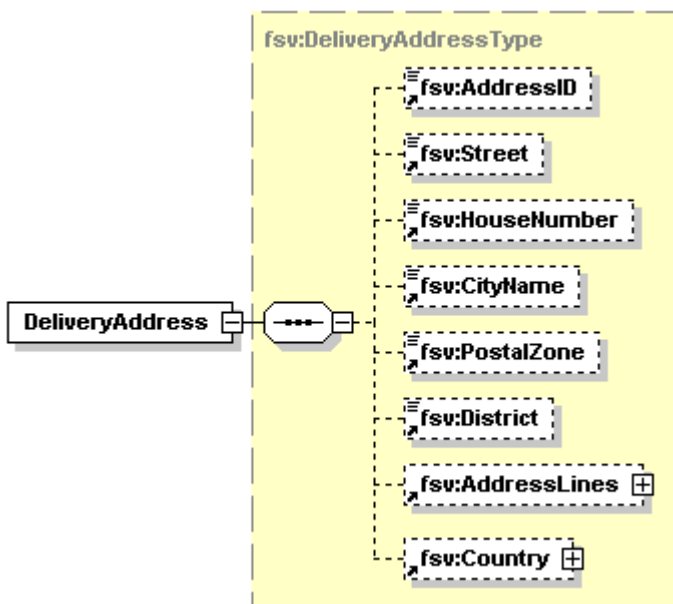

namespace <http://rep.oiio.dk/ubl/xml/schemas/Op71/extensible/businessdomain/utilities/2005/10/11/>

type [fsv:DeliveryAddressType](#)

properties content complex

children [fsv:AddressID](#) [fsv:Street](#) [fsv:HouseNumber](#) [fsv:CityName](#) [fsv:PostalZone](#) [fsv:District](#) [fsv:AddressLines](#) [fsv:Country](#)

used by complexType [ConsumptionPointAddressType](#)

source `<xsd:element name="DeliveryAddress" type="fsv:DeliveryAddressType"/>`

## element DeliveryDate

diagram

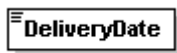

namespace <http://rep.oiio.dk/ubl/xml/schemas/Op71/extensible/businessdomain/utilities/2005/10/11/>

type `xsd:date`

properties content simple

used by complexTypes [UtilityInvoiceType](#) [UtilitySubInvoiceLineType](#)

source `<xsd:element name="DeliveryDate" type="xsd:date"/>`

## element DeliveryMeterInformation

diagram

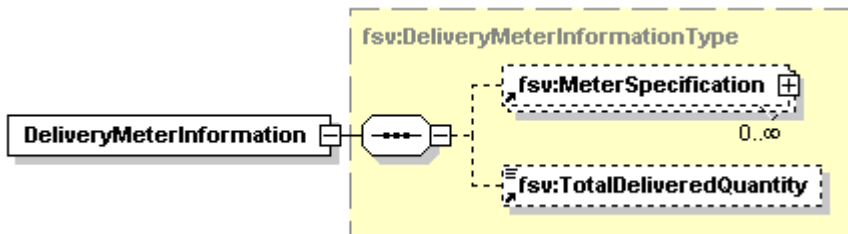

namespace <http://rep.oiio.dk/ubl/xml/schemas/Op71/extensible/businessdomain/utilities/2005/10/11/>

type [fsv:DeliveryMeterInformationType](#)

properties content complex

children [fsv:MeterSpecification](#) [fsv:TotalDeliveredQuantity](#)

used by complexType [UtilityInvoiceType](#)

source `<xsd:element name="DeliveryMeterInformation" type="fsv:DeliveryMeterInformationType"/>`

## element DeliveryOnAccountPaymentSchedule

diagram

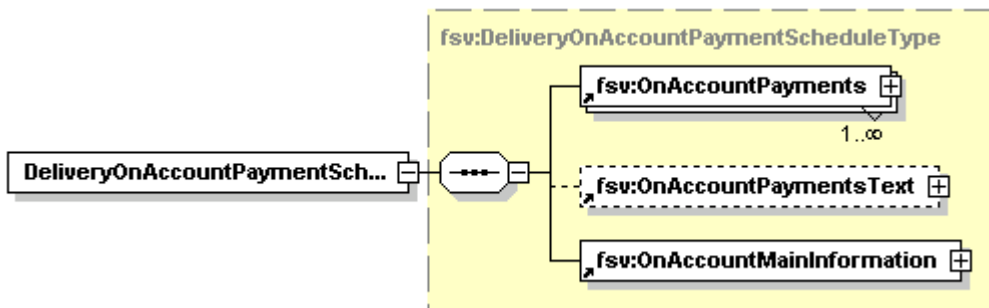

namespace <http://rep.oio.dk/ubl/xml/schemas/0p71/extensible/businessdomain/utilities/2005/10/11/>  
 type [fsv:DeliveryOnAccountPaymentScheduleType](#)  
 properties content complex  
 children [fsv:OnAccountPayments](#) [fsv:OnAccountPaymentsText](#) [fsv:OnAccountMainInformation](#)  
 used by complexType [UtilityInvoiceType](#)  
 source `<xsd:element name="DeliveryOnAccountPaymentSchedule" type="fsv:DeliveryOnAccountPaymentScheduleType"/>`

## element **DeliveryTaxInformation**

diagram

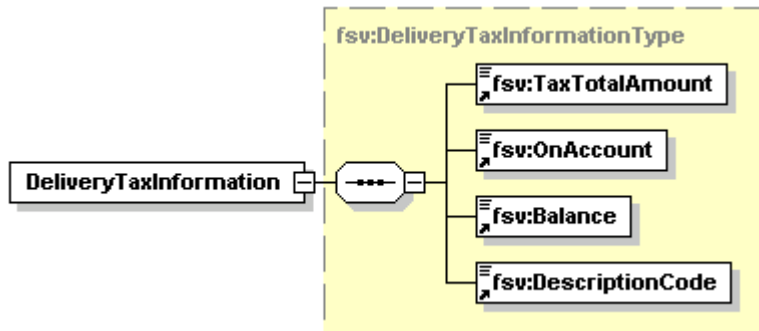

namespace <http://rep.oio.dk/ubl/xml/schemas/0p71/extensible/businessdomain/utilities/2005/10/11/>  
 type [fsv:DeliveryTaxInformationType](#)  
 properties content complex  
 children [fsv:TaxTotalAmount](#) [fsv:OnAccount](#) [fsv:Balance](#) [fsv:DescriptionCode](#)  
 source `<xsd:element name="DeliveryTaxInformation" type="fsv:DeliveryTaxInformationType"/>`

## element **Description**

diagram

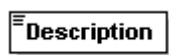

namespace <http://rep.oio.dk/ubl/xml/schemas/0p71/extensible/businessdomain/utilities/2005/10/11/>  
 type `xsd:string`  
 properties content simple  
 used by complexTypes [DescriptionsType](#) [EnergyTaxInformationDetailType](#) [ItemType](#) [UtilityInvoiceType](#) [UtilityLegalTotalsType](#) [UtilitySubLegalTotalsType](#)  
 source `<xsd:element name="Description" type="xsd:string"/>`

## element **DescriptionCode**

diagram

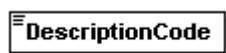

namespace <http://rep.oio.dk/ubl/xml/schemas/0p71/extensible/businessdomain/utilities/2005/10/11/>  
 type `xsd:string`  
 properties content simple  
 used by complexTypes [DeliveryTaxInformationType](#) [EnergyTaxInformationDetailType](#)  
 source `<xsd:element name="DescriptionCode" type="xsd:string"/>`

## element Descriptions

diagram

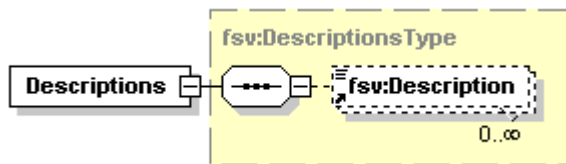

namespace <http://rep.oio.dk/ubl/xml/schemas/0p71/extensible/businessdomain/utilities/2005/10/11/>

type [fsv:DescriptionsType](#)

properties content complex

children [fsv:Description](#)

used by complexType [UtilitySubInvoiceHeaderType](#)

source `<xsd:element name="Descriptions" type="fsv:DescriptionsType"/>`

## element DevelopmentInConsumption

diagram

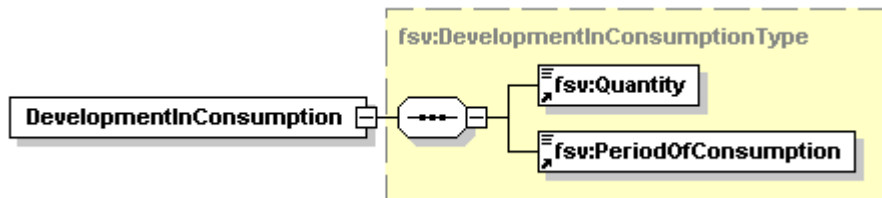

namespace <http://rep.oio.dk/ubl/xml/schemas/0p71/extensible/businessdomain/utilities/2005/10/11/>

type [fsv:DevelopmentInConsumptionType](#)

properties content complex

children [fsv:Quantity](#) [fsv:PeriodOfConsumption](#)

used by complexType [UtilityInvoiceType](#)

source `<xsd:element name="DevelopmentInConsumption" type="fsv:DevelopmentInConsumptionType"/>`

## element Discount

diagram

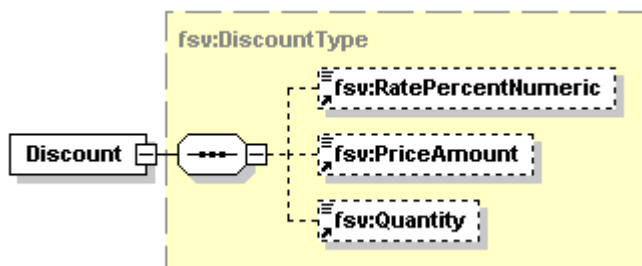

namespace <http://rep.oio.dk/ubl/xml/schemas/0p71/extensible/businessdomain/utilities/2005/10/11/>

type [fsv:DiscountType](#)

properties content complex

children [fsv:RatePercentNumeric](#) [fsv:PriceAmount](#) [fsv:Quantity](#)

used by complexType [ItemType](#)

source `<xsd:element name="Discount" type="fsv:DiscountType"/>`

### element **District**



namespace `http://rep.oiio.dk/ubl/xml/schemas/0p71/extensible/businessdomain/utilities/2005/10/11/`

type `xsd:string`

properties content simple

used by complexType [DeliveryAddressType](#)

source `<xsd:element name="District" type="xsd:string"/>`

### element **DuePaymentDate**

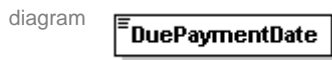

namespace `http://rep.oiio.dk/ubl/xml/schemas/0p71/extensible/businessdomain/utilities/2005/10/11/`

type `xsd:date`

properties content simple

used by complexType [OnAccountPaymentsType](#)

source `<xsd:element name="DuePaymentDate" type="xsd:date"/>`

### element **EndDate**



namespace `http://rep.oiio.dk/ubl/xml/schemas/0p71/extensible/businessdomain/utilities/2005/10/11/`

type `xsd:date`

properties content simple

used by complexTypes [InvoicedPeriodType](#) [PeriodType](#) [UtilityInvoiceMainPeriodType](#)

source `<xsd:element name="EndDate" type="xsd:date"/>`

### element **EnergyTaxInformation**

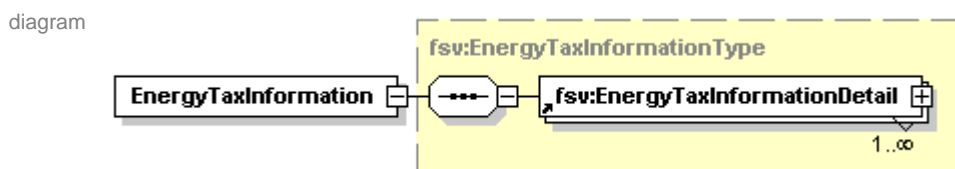

namespace `http://rep.oiio.dk/ubl/xml/schemas/0p71/extensible/businessdomain/utilities/2005/10/11/`

type [fsv:EnergyTaxInformationType](#)

properties content complex

children [fsv:EnergyTaxInformationDetail](#)

used by complexType [UtilityInvoiceType](#)

source `<xsd:element name="EnergyTaxInformation" type="fsv:EnergyTaxInformationType"/>`

## element **EnergyTaxInformationDetail**

diagram

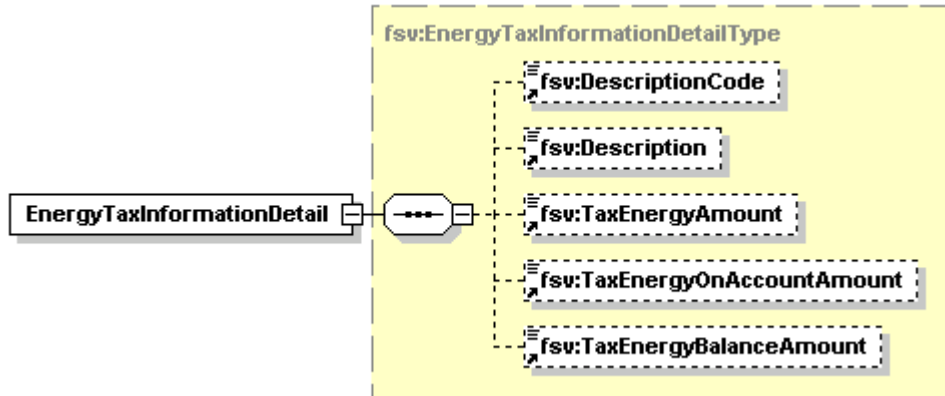

namespace `http://rep.oiio.dk/ubl/xml/schemas/0p71/extensible/businessdomain/utilities/2005/10/11/`

type [fsv:EnergyTaxInformationDetailType](#)

properties content complex

children [fsv:DescriptionCode](#) [fsv:Description](#) [fsv:TaxEnergyAmount](#) [fsv:TaxEnergyOnAccountAmount](#) [fsv:TaxEnergyBalanceAmount](#)

used by complexType [EnergyTaxInformationType](#)

source `<xsd:element name="EnergyTaxInformationDetail" type="fsv:EnergyTaxInformationDetailType"/>`

## element **FSV**

diagram

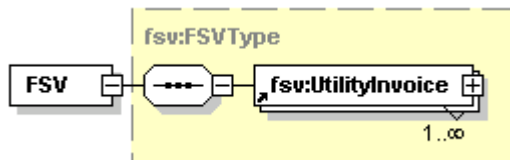

namespace `http://rep.oiio.dk/ubl/xml/schemas/0p71/extensible/businessdomain/utilities/2005/10/11/`

type [fsv:FSVType](#)

properties content complex

children [fsv:UtilityInvoice](#)

source `<xsd:element name="FSV" type="fsv:FSVType"/>`

## element **HouseNumber**

diagram



namespace `http://rep.oiio.dk/ubl/xml/schemas/0p71/extensible/businessdomain/utilities/2005/10/11/`

type `xsd:string`

properties content simple

used by complexTypes [DeliveryAddressType](#) [InstallationAddressType](#) [ItemAddressType](#)

source `<xsd:element name="HouseNumber" type="xsd:string"/>`

## element ID

diagram



namespace <http://rep.oio.dk/ubl/xml/schemas/0p71/extensible/businessdomain/utilities/2005/10/11/>

type **xsd:string**

properties content simple

used by complexTypes [ItemAddressType](#) [ItemType](#) [UtilitySubInvoiceLineType](#)

source `<xsd:element name="ID" type="xsd:string"/>`

## element InstallationAddress

diagram

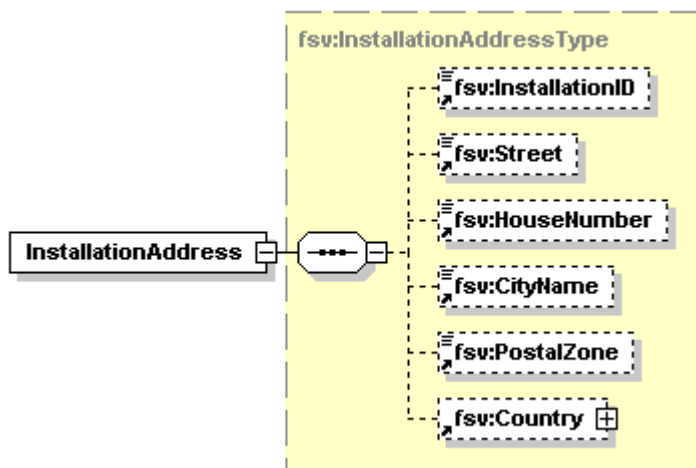

namespace <http://rep.oio.dk/ubl/xml/schemas/0p71/extensible/businessdomain/utilities/2005/10/11/>

type [fsv:InstallationAddressType](#)

properties content complex

children [fsv:InstallationID](#) [fsv:Street](#) [fsv:HouseNumber](#) [fsv:CityName](#) [fsv:PostalZone](#) [fsv:Country](#)

used by complexType [CustomerType](#)

source `<xsd:element name="InstallationAddress" type="fsv:InstallationAddressType"/>`

## element InstallationID

diagram



namespace <http://rep.oio.dk/ubl/xml/schemas/0p71/extensible/businessdomain/utilities/2005/10/11/>

type **xsd:string**

properties content simple

used by complexType [InstallationAddressType](#)

source `<xsd:element name="InstallationID" type="xsd:string"/>`



## element InvoicedPeriod

diagram

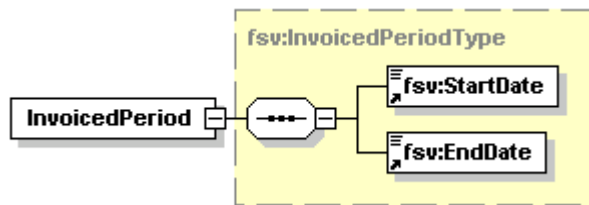

namespace <http://rep.oio.dk/ubl/xml/schemas/0p71/extensible/businessdomain/utilities/2005/10/11/>

type [fsv:InvoicedPeriodType](#)

properties content complex

children [fsv:StartDate](#) [fsv:EndDate](#)

used by complexType [OnAccountMainInformationType](#)

source `<xsd:element name="InvoicedPeriod" type="fsv:InvoicedPeriodType"/>`

## element InvoicedQuantity

diagram

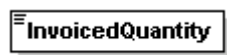

namespace <http://rep.oio.dk/ubl/xml/schemas/0p71/extensible/businessdomain/utilities/2005/10/11/>

type [fsv:QuantityType](#)

properties content complex

used by complexType [UtilitySubInvoiceLineType](#)

attributes	Name	Type	Use	Default	Fixed	Annotation
	quantityUnitCode	xsd:string	required			

source `<xsd:element name="InvoicedQuantity" type="fsv:QuantityType"/>`

## element **Item**

diagram

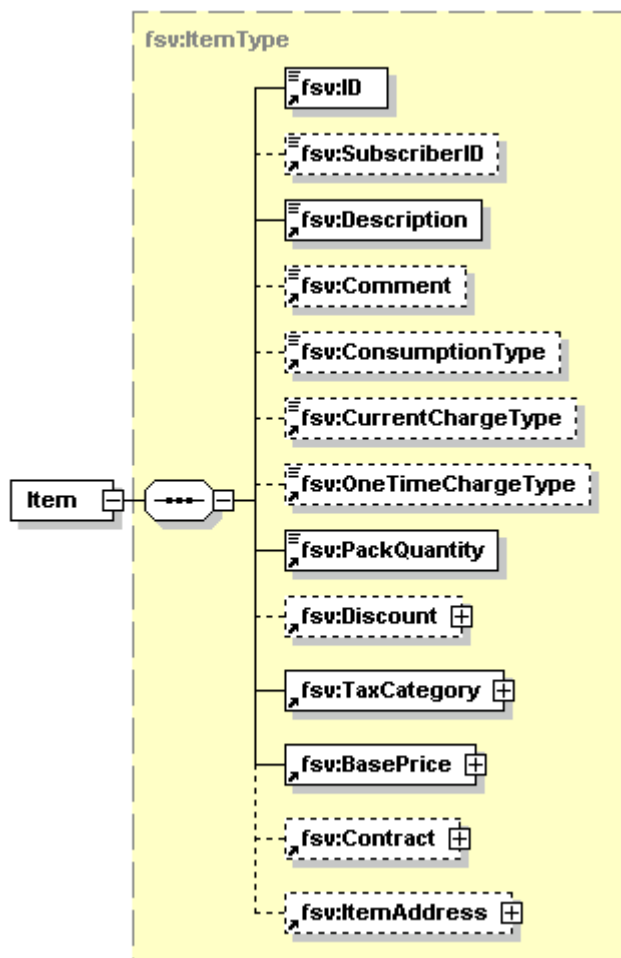

namespace <http://rep.oio.dk/ubl/xml/schemas/0p71/extensible/businessdomain/utilities/2005/10/11/>

type [fsv:ItemType](#)

properties content complex

children [fsv:ID](#) [fsv:SubscriberID](#) [fsv:Description](#) [fsv:Comment](#) [fsv:ConsumptionType](#) [fsv:CurrentChargeType](#) [fsv:OneTimeChargeType](#) [fsv:PackQuantity](#) [fsv:Discount](#) [fsv:TaxCategory](#) [fsv:BasePrice](#) [fsv:Contract](#) [fsv:ItemAddress](#)

used by complexType [UtilitySubInvoiceLineType](#)

source `<xsd:element name="Item" type="fsv:ItemType"/>`

## element **ItemAddress**

diagram

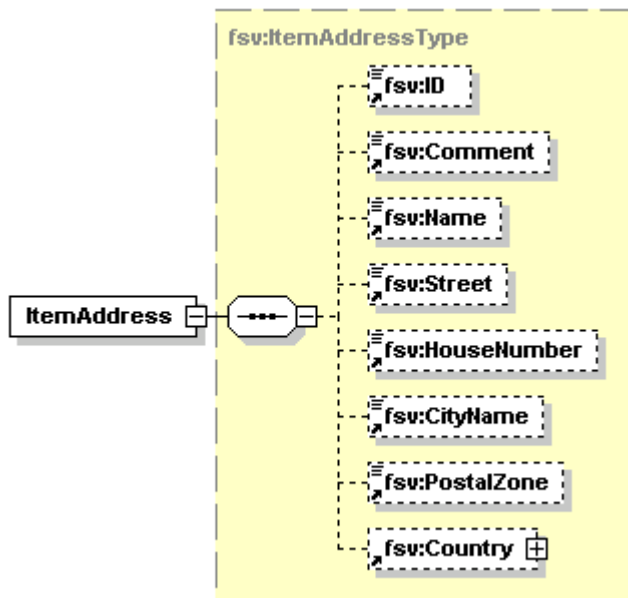

namespace <http://rep.oio.dk/ubl/xml/schemas/0p71/extensible/businessdomain/utilities/2005/10/11/>

type [fsv:ItemAddressType](#)

properties content complex

children [fsv:ID](#) [fsv:Comment](#) [fsv:Name](#) [fsv:Street](#) [fsv:HouseNumber](#) [fsv:CityName](#) [fsv:PostalZone](#) [fsv:Country](#)

used by complexType [ItemType](#)

source `<xsd:element name="ItemAddress" type="fsv:ItemAddressType"/>`

## element **LatestMeterReadingDate**

diagram



namespace <http://rep.oio.dk/ubl/xml/schemas/0p71/extensible/businessdomain/utilities/2005/10/11/>

type `xsd:date`

properties content simple

used by complexType [MeterReadingType](#)

source `<xsd:element name="LatestMeterReadingDate" type="xsd:date"/>`

## element **LatestMeterStand**

diagram



namespace <http://rep.oio.dk/ubl/xml/schemas/0p71/extensible/businessdomain/utilities/2005/10/11/>

type [fsv:QuantityType](#)

properties content complex

used by complexType [MeterReadingType](#)

attributes	Name	Type	Use	Default	Fixed	Annotation
	quantityUnitCode	<b>xsd:string</b>	required			

source `<xsd:element name="LatestMeterStand" type="fsv:QuantityType"/>`

## element Line



namespace	http://rep.oio.dk/ubl/xml/schemas/0p71/extensible/businessdomain/utilities/2005/10/11/					
type	<b>xsd:string</b>					
properties	content simple					
used by	complexType	<a href="#">AddressLinesType</a>				

source `<xsd:element name="Line" type="xsd:string"/>`

## element LineExtensionAmount

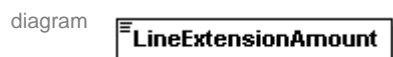

namespace	http://rep.oio.dk/ubl/xml/schemas/0p71/extensible/businessdomain/utilities/2005/10/11/					
type	<a href="#">fsv:AmountType</a>					
properties	content complex					
used by	complexType	<a href="#">UtilitySubInvoiceLineType</a>				

attributes	Name	Type	Use	Default	Fixed	Annotation
	currencyID	<b>xsd:string</b>	optional	DKK		

source `<xsd:element name="LineExtensionAmount" type="fsv:AmountType"/>`

## element LineExtensionAmountBeforeDiscount

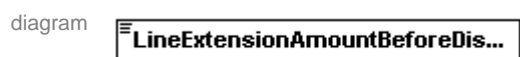

namespace	http://rep.oio.dk/ubl/xml/schemas/0p71/extensible/businessdomain/utilities/2005/10/11/					
type	<a href="#">fsv:AmountType</a>					
properties	content complex					
used by	complexType	<a href="#">UtilitySubInvoiceLineType</a>				

attributes	Name	Type	Use	Default	Fixed	Annotation
	currencyID	<b>xsd:string</b>	optional	DKK		

source `<xsd:element name="LineExtensionAmountBeforeDiscount" type="fsv:AmountType"/>`

## element LineExtensionTotalAmount

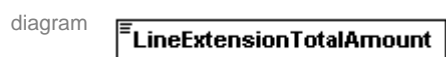

namespace	http://rep.oio.dk/ubl/xml/schemas/0p71/extensible/businessdomain/utilities/2005/10/11/					
type	<a href="#">fsv:AmountType</a>					
properties	content complex					
used by	complexType	<a href="#">UtilitySubLegalTotalsType</a>				

attributes	Name	Type	Use	Default	Fixed	Annotation
	currencyID	<b>xsd:string</b>	optional	DKK		

source `<xsd:element name="LineExtensionTotalAmount" type="fsv:AmountType"/>`

### element **LineID**



namespace <http://rep.oio.dk/ubl/xml/schemas/0p71/extensible/businessdomain/utilities/2005/10/11/>

type **xsd:string**

properties content simple

source `<xsd:element name="LineID" type="xsd:string"/>`

### element **MainSubscriberID**

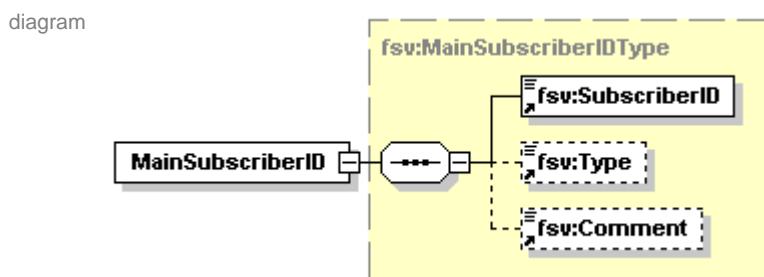

namespace <http://rep.oio.dk/ubl/xml/schemas/0p71/extensible/businessdomain/utilities/2005/10/11/>

type [fsv:MainSubscriberIDType](#)

properties content complex

children [fsv:SubscriberID](#) [fsv:Type](#) [fsv:Comment](#)

used by complexType [AdditionalSpecificationType](#)

source `<xsd:element name="MainSubscriberID" type="fsv:MainSubscriberIDType"/>`

### element **MeterConstant**



namespace <http://rep.oio.dk/ubl/xml/schemas/0p71/extensible/businessdomain/utilities/2005/10/11/>

type [fsv:QuantityType](#)

properties content complex

used by complexType [MeteringPointType](#)

attributes	Name	Type	Use	Default	Fixed	Annotation
	quantityUnitCode	<b>xsd:string</b>	required			

source `<xsd:element name="MeterConstant" type="fsv:QuantityType"/>`

## element **MeteringPoint**

diagram

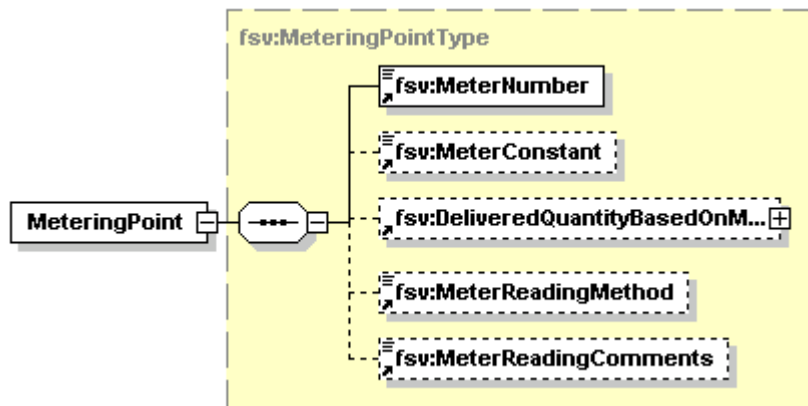

namespace <http://rep.oio.dk/ubl/xml/schemas/0p71/extensible/businessdomain/utilities/2005/10/11/>

type [fsv:MeteringPointType](#)

properties content complex

children [fsv:MeterNumber](#) [fsv:MeterConstant](#) [fsv:DeliveredQuantityBasedOnMeterReadings](#) [fsv:MeterReadingMethod](#) [fsv:MeterReadingComments](#)

used by complexType [MeterSpecificationType](#)

source `<xsd:element name="MeteringPoint" type="fsv:MeteringPointType"/>`

## element **MeterNumber**

diagram



namespace <http://rep.oio.dk/ubl/xml/schemas/0p71/extensible/businessdomain/utilities/2005/10/11/>

type `xsd:string`

properties content simple

used by complexTypes [ConsumptionPointType](#) [MeteringPointType](#)

source `<xsd:element name="MeterNumber" type="xsd:string"/>`

## element **MeterReading**

diagram

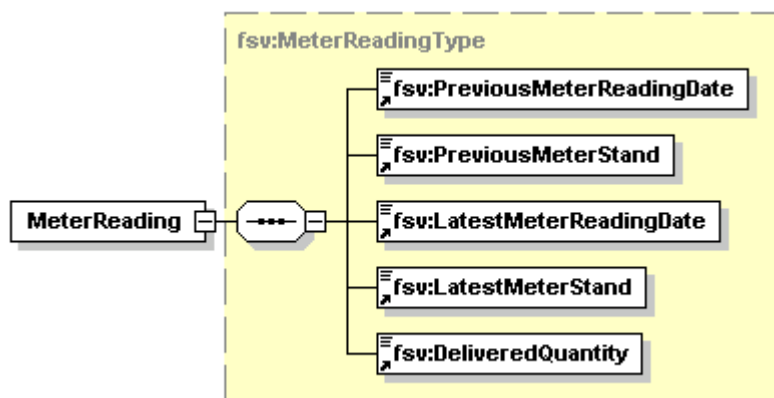

namespace <http://rep.oio.dk/ubl/xml/schemas/0p71/extensible/businessdomain/utilities/2005/10/11/>

type [fsv:MeterReadingType](#)

properties content complex

children [fsv:PreviousMeterReadingDate](#) [fsv:PreviousMeterStand](#) [fsv:LatestMeterReadingDate](#) [fsv:LatestMeterStand](#) [fsv:DeliveredQuantity](#)

used by complexType [DeliveredQuantityBasedOnMeterReadingsType](#)

source `<xsd:element name="MeterReading" type="fsv:MeterReadingType"/>`

## element **MeterReadingComments**

diagram



namespace <http://rep.oio.dk/ubl/xml/schemas/0p71/extensible/businessdomain/utilities/2005/10/11/>

type `xsd:string`

properties content simple

used by complexType [MeteringPointType](#)

source `<xsd:element name="MeterReadingComments" type="xsd:string"/>`

## element **MeterReadingMethod**

diagram



namespace <http://rep.oio.dk/ubl/xml/schemas/0p71/extensible/businessdomain/utilities/2005/10/11/>

type `xsd:string`

properties content simple

used by complexType [MeteringPointType](#)

source `<xsd:element name="MeterReadingMethod" type="xsd:string"/>`

## element **MeterSpecification**

diagram

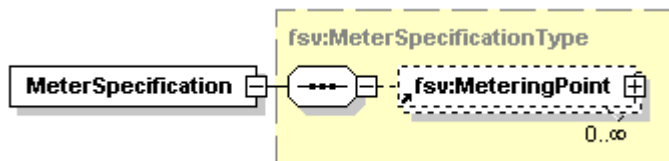

namespace <http://rep.oio.dk/ubl/xml/schemas/0p71/extensible/businessdomain/utilities/2005/10/11/>

type [fsv:MeterSpecificationType](#)

properties content complex

children [fsv:MeteringPoint](#)

used by complexType [DeliveryMeterInformationType](#)

source `<xsd:element name="MeterSpecification" type="fsv:MeterSpecificationType"/>`

## element Name



namespace <http://rep.oio.dk/ubl/xml/schemas/0p71/extensible/businessdomain/utilities/2005/10/11/>

type **xsd:string**

properties content simple

used by complexTypes [ConsumptionPointAddressType](#) [ItemAddressType](#) [PartyNameType](#)

source `<xsd:element name="Name" type="xsd:string"/>`

## element OioLineRefID



namespace <http://rep.oio.dk/ubl/xml/schemas/0p71/extensible/businessdomain/utilities/2005/10/11/>

type **xsd:string**

properties content simple

used by complexType [UtilitySubInvoiceLineType](#)

source `<xsd:element name="OioLineRefID" type="xsd:string"/>`

## element OnAccount



namespace <http://rep.oio.dk/ubl/xml/schemas/0p71/extensible/businessdomain/utilities/2005/10/11/>

type [fsv:AmountType](#)

properties content complex

used by complexType [DeliveryTaxInformationType](#)

attributes	Name	Type	Use	Default	Fixed	Annotation
	currencyID	<b>xsd:string</b>	optional	DKK		

source `<xsd:element name="OnAccount" type="fsv:AmountType"/>`

## element OnAccountMainInformation

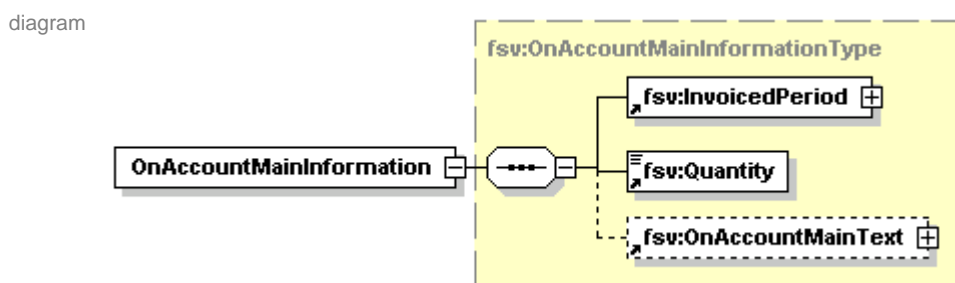

namespace <http://rep.oio.dk/ubl/xml/schemas/0p71/extensible/businessdomain/utilities/2005/10/11/>

type [fsv:OnAccountMainInformationType](#)



properties content complex

children [fsv:InvoicedPeriod](#) [fsv:Quantity](#) [fsv:OnAccountMainText](#)

used by complexType [DeliveryOnAccountPaymentScheduleType](#)

source `<xsd:element name="OnAccountMainInformation" type="fsv:OnAccountMainInformationType"/>`

## element **OnAccountMainText**

diagram

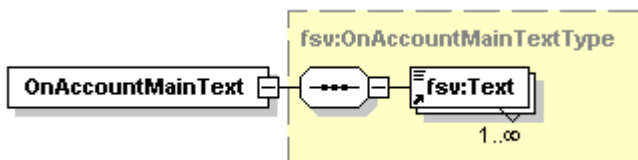

namespace <http://rep.oio.dk/ubl/xml/schemas/0p71/extensible/businessdomain/utilities/2005/10/11/>

type [fsv:OnAccountMainTextType](#)

properties content complex

children [fsv:Text](#)

used by complexType [OnAccountMainInformationType](#)

source `<xsd:element name="OnAccountMainText" type="fsv:OnAccountMainTextType"/>`

## element **OnAccountPayments**

diagram

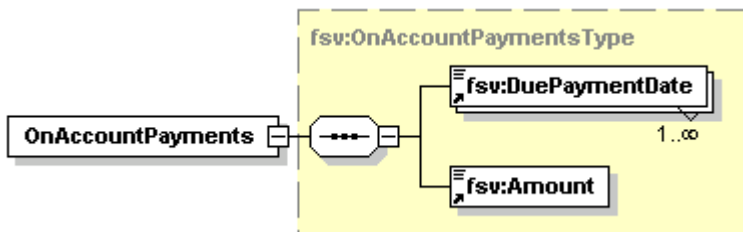

namespace <http://rep.oio.dk/ubl/xml/schemas/0p71/extensible/businessdomain/utilities/2005/10/11/>

type [fsv:OnAccountPaymentsType](#)

properties content complex

children [fsv:DuePaymentDate](#) [fsv:Amount](#)

used by complexType [DeliveryOnAccountPaymentScheduleType](#)

source `<xsd:element name="OnAccountPayments" type="fsv:OnAccountPaymentsType"/>`

## element **OnAccountPaymentsText**

diagram

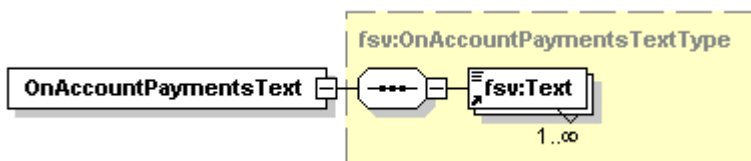

namespace <http://rep.oio.dk/ubl/xml/schemas/0p71/extensible/businessdomain/utilities/2005/10/11/>

type [fsv:OnAccountPaymentsTextType](#)

properties content complex

children [fsv:Text](#)

used by complexType [DeliveryOnAccountPaymentScheduleType](#)

source `<xsd:element name="OnAccountPaymentsText" type="fsv:OnAccountPaymentsTextType"/>`

## element **OneTimeChargeType**

diagram 

namespace <http://rep.oio.dk/ubl/xml/schemas/0p71/extensible/businessdomain/utilities/2005/10/11/>

type **xsd:string**

properties content simple

used by complexType [ItemType](#)

source `<xsd:element name="OneTimeChargeType" type="xsd:string"/>`

## element **PackQuantity**

diagram 

namespace <http://rep.oio.dk/ubl/xml/schemas/0p71/extensible/businessdomain/utilities/2005/10/11/>

type [fsv:QuantityType](#)

properties content complex

used by complexType [ItemType](#)

attributes	Name	Type	Use	Default	Fixed	Annotation
	quantityUnitCode	<b>xsd:string</b>	required			

source `<xsd:element name="PackQuantity" type="fsv:QuantityType"/>`

## element **PartyID**

diagram 

namespace <http://rep.oio.dk/ubl/xml/schemas/0p71/extensible/businessdomain/utilities/2005/10/11/>

type **xsd:string**

properties content simple

used by complexType [PartyIdentificationType](#)

source `<xsd:element name="PartyID" type="xsd:string"/>`

## element PartyIdentification

diagram

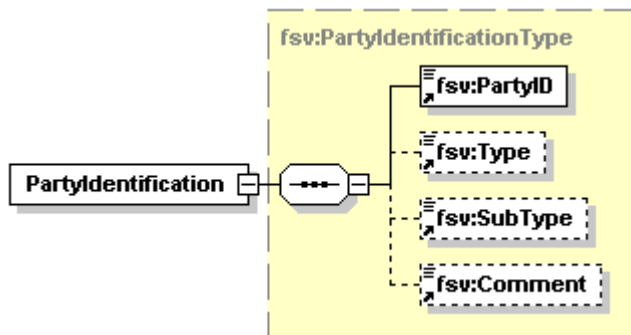

namespace <http://rep.oio.dk/ubl/xml/schemas/0p71/extensible/businessdomain/utilities/2005/10/11/>

type [fsv:PartyIdentificationType](#)

properties content complex

children [fsv:PartyID](#) [fsv:Type](#) [fsv:Sub Type](#) [fsv:Comment](#)

used by complexTypes [CustomerType](#) [SupplierType](#)

source `<xsd:element name="PartyIdentification" type="fsv:PartyIdentificationType"/>`

## element PartyName

diagram

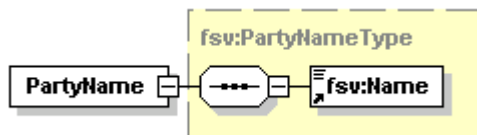

namespace <http://rep.oio.dk/ubl/xml/schemas/0p71/extensible/businessdomain/utilities/2005/10/11/>

type [fsv:PartyNameType](#)

properties content complex

children [fsv:Name](#)

used by complexTypes [CustomerType](#) [SupplierType](#)

source `<xsd:element name="PartyName" type="fsv:PartyNameType"/>`

## element Period

diagram

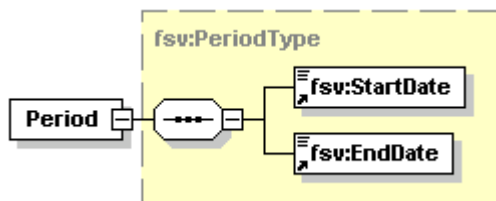

namespace <http://rep.oio.dk/ubl/xml/schemas/0p71/extensible/businessdomain/utilities/2005/10/11/>

type [fsv:PeriodType](#)

properties content complex

children [fsv:StartDate](#) [fsv:EndDate](#)

used by complexType [UtilitySubInvoiceLineType](#)  
source `<xsd:element name="Period" type="fsv:PeriodType"/>`

## element **PeriodOfConsumption**

diagram 

namespace <http://rep.oio.dk/ubl/xml/schemas/0p71/extensible/businessdomain/utilities/2005/10/11/>  
type **xsd:string**  
properties content simple  
used by complexType [DevelopmentInConsumptionType](#)  
source `<xsd:element name="PeriodOfConsumption" type="xsd:string"/>`

## element **PostalZone**

diagram 

namespace <http://rep.oio.dk/ubl/xml/schemas/0p71/extensible/businessdomain/utilities/2005/10/11/>  
type **xsd:string**  
properties content simple  
used by complexTypes [DeliveryAddressType](#) [InstallationAddressType](#) [ItemAddressType](#)  
source `<xsd:element name="PostalZone" type="xsd:string"/>`

## element **PreviousMeterReadingDate**

diagram 

namespace <http://rep.oio.dk/ubl/xml/schemas/0p71/extensible/businessdomain/utilities/2005/10/11/>  
type **xsd:date**  
properties content simple  
used by complexType [MeterReadingType](#)  
source `<xsd:element name="PreviousMeterReadingDate" type="xsd:date"/>`

## element **PreviousMeterStand**

diagram 

namespace <http://rep.oio.dk/ubl/xml/schemas/0p71/extensible/businessdomain/utilities/2005/10/11/>  
type [fsv:QuantityType](#)  
properties content complex  
used by complexType [MeterReadingType](#)  
attributes

Name	Type	Use	Default	Fixed	Annotation
quantityUnitCode	<b>xsd:string</b>	required			

source `<xsd:element name="PreviousMeterStand" type="fsv:QuantityType"/>`

## element PriceAmount

diagram

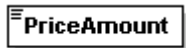

namespace <http://rep.oio.dk/ubl/xml/schemas/0p71/extensible/businessdomain/utilities/2005/10/11/>

type [fsv:AmountType](#)

properties content complex

used by complexTypes [BasePriceType](#) [DiscountType](#)

attributes	Name	Type	Use	Default	Fixed	Annotation
	currencyID	<b>xsd:string</b>	optional	DKK		

source `<xsd:element name="PriceAmount" type="fsv:AmountType"/>`

## element Quantity

diagram

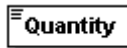

namespace <http://rep.oio.dk/ubl/xml/schemas/0p71/extensible/businessdomain/utilities/2005/10/11/>

type [fsv:QuantityType](#)

properties content complex

used by complexTypes [DevelopmentInConsumptionType](#) [DiscountType](#) [OnAccountMainInformationType](#)

attributes	Name	Type	Use	Default	Fixed	Annotation
	quantityUnitCode	<b>xsd:string</b>	required			

source `<xsd:element name="Quantity" type="fsv:QuantityType"/>`

## element RateCategoryCodeID

diagram

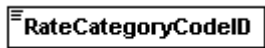

namespace <http://rep.oio.dk/ubl/xml/schemas/0p71/extensible/businessdomain/utilities/2005/10/11/>

type **xsd:string**

properties content simple

used by complexType [CategoryTotalType](#)

source `<xsd:element name="RateCategoryCodeID" type="xsd:string"/>`

## element RatePercentNumeric

diagram

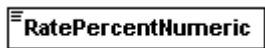

namespace <http://rep.oio.dk/ubl/xml/schemas/0p71/extensible/businessdomain/utilities/2005/10/11/>

type **xsd:string**

properties content simple

used by complexTypes [CategoryTotalType](#) [DiscountType](#) [TaxCategoryType](#)

source `<xsd:element name="RatePercentNumeric" type="xsd:string"/>`

### element RefID



namespace <http://rep.oio.dk/ubl/xml/schemas/0p71/extensible/businessdomain/utilities/2005/10/11/>  
type **xsd:string**  
properties content simple  
used by complexType [BuyerPartyType](#)  
source `<xsd:element name="RefID" type="xsd:string"/>`

### element ServiceAmount



namespace <http://rep.oio.dk/ubl/xml/schemas/0p71/extensible/businessdomain/utilities/2005/10/11/>  
type [fsv:AmountType](#)  
properties content complex  
used by complexType [ServiceChargeType](#)  
attributes 

Name	Type	Use	Default	Fixed	Annotation
currencyID	<b>xsd:string</b>	optional	DKK		

  
source `<xsd:element name="ServiceAmount" type="fsv:AmountType"/>`

### element ServiceCharge

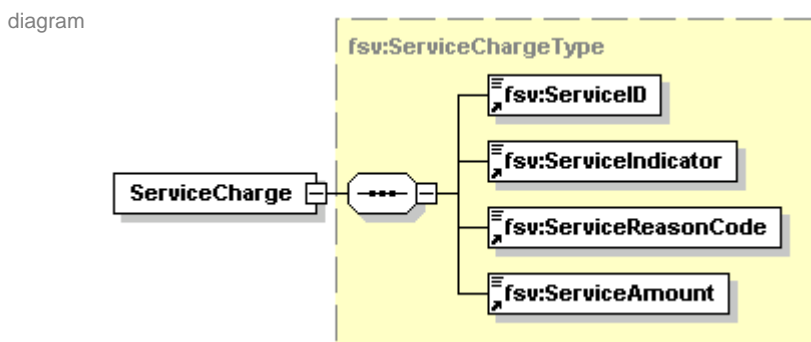

namespace <http://rep.oio.dk/ubl/xml/schemas/0p71/extensible/businessdomain/utilities/2005/10/11/>  
type [fsv:ServiceChargeType](#)  
properties content complex  
children [fsv:ServiceID](#) [fsv:ServiceIndicator](#) [fsv:ServiceReasonCode](#) [fsv:ServiceAmount](#)  
used by complexType [UtilityLegalTotalsType](#)  
source `<xsd:element name="ServiceCharge" type="fsv:ServiceChargeType"/>`

### element ServiceID



namespace <http://rep.oio.dk/ubl/xml/schemas/0p71/extensible/businessdomain/utilities/2005/10/11/>

type **xsd:string**

properties content simple

used by complexType [ServiceChargeType](#)

source `<xsd:element name="ServiceID" type="xsd:string"/>`

## element **ServiceIndicator**

diagram

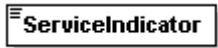

namespace <http://rep.oio.dk/ubl/xml/schemas/0p71/extensible/businessdomain/utilities/2005/10/11/>

type **xsd:string**

properties content simple

used by complexType [ServiceChargeType](#)

source `<xsd:element name="ServiceIndicator" type="xsd:string"/>`

## element **ServiceReasonCode**

diagram

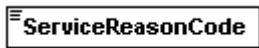

namespace <http://rep.oio.dk/ubl/xml/schemas/0p71/extensible/businessdomain/utilities/2005/10/11/>

type **xsd:string**

properties content simple

used by complexType [ServiceChargeType](#)

source `<xsd:element name="ServiceReasonCode" type="xsd:string"/>`

## element **StartDate**

diagram



namespace <http://rep.oio.dk/ubl/xml/schemas/0p71/extensible/businessdomain/utilities/2005/10/11/>

type **xsd:date**

properties content simple

used by complexTypes [InvoicedPeriodType](#) [PeriodType](#) [UtilityInvoiceMainPeriodType](#)

source `<xsd:element name="StartDate" type="xsd:date"/>`

## element **Street**

diagram



namespace <http://rep.oio.dk/ubl/xml/schemas/0p71/extensible/businessdomain/utilities/2005/10/11/>

type **xsd:string**

properties content simple

used by complexTypes [DeliveryAddressType](#) [InstallationAddressType](#) [ItemAddressType](#)

source `<xsd:element name="Street" type="xsd:string"/>`

## element **SubscriberID**



namespace <http://rep.oio.dk/ubl/xml/schemas/0p71/extensible/businessdomain/utilities/2005/10/11/>

type **xsd:string**

properties content simple

used by complexTypes [ItemType](#) [MainSubscriberIDType](#)

source `<xsd:element name="SubscriberID" type="xsd:string"/>`

## element **SubType**

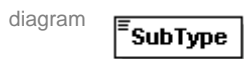

namespace <http://rep.oio.dk/ubl/xml/schemas/0p71/extensible/businessdomain/utilities/2005/10/11/>

type **xsd:string**

properties content simple

used by complexType [PartyIdentificationType](#)

source `<xsd:element name="SubType" type="xsd:string"/>`

## element **Supplier**

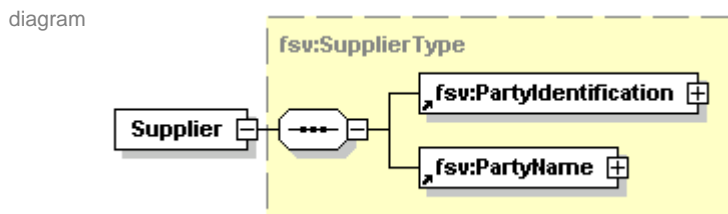

namespace <http://rep.oio.dk/ubl/xml/schemas/0p71/extensible/businessdomain/utilities/2005/10/11/>

type [fsv:SupplierType](#)

properties content complex

children [fsv:PartyIdentification](#) [fsv:PartyName](#)

used by complexType [UtilitySubInvoiceHeaderType](#)

source `<xsd:element name="Supplier" type="fsv:SupplierType"/>`

## element **TaxableAmount**

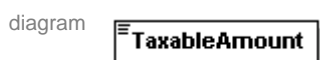

namespace <http://rep.oio.dk/ubl/xml/schemas/0p71/extensible/businessdomain/utilities/2005/10/11/>

type [fsv:AmountType](#)



properties content complex

used by complexType [TaxAmountsType](#)

attributes	Name	Type	Use	Default	Fixed	Annotation
currencyID		xsd:string	optional	DKK		

source `<xsd:element name="TaxableAmount" type="fsv:AmountType"/>`

### element TaxAmount



namespace <http://rep.oio.dk/ubl/xml/schemas/0p71/extensible/businessdomain/utilities/2005/10/11/>

type [fsv:AmountType](#)

properties content complex

used by complexType [TaxAmountsType](#)

attributes	Name	Type	Use	Default	Fixed	Annotation
currencyID		xsd:string	optional	DKK		

source `<xsd:element name="TaxAmount" type="fsv:AmountType"/>`

### element TaxAmounts

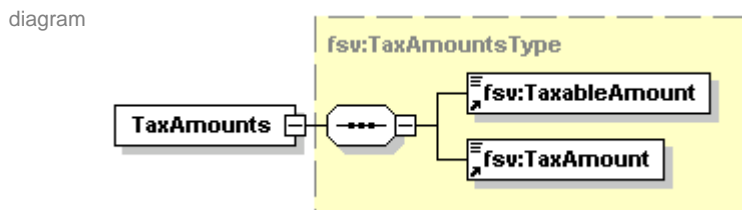

namespace <http://rep.oio.dk/ubl/xml/schemas/0p71/extensible/businessdomain/utilities/2005/10/11/>

type [fsv:TaxAmountsType](#)

properties content complex

children [fsv:TaxableAmount](#) [fsv:TaxAmount](#)

used by complexTypes [CategoryTotalType](#) [UtilitySubTaxTotalType](#) [UtilityTaxTotalType](#)

source `<xsd:element name="TaxAmounts" type="fsv:TaxAmountsType"/>`

### element TaxCategory

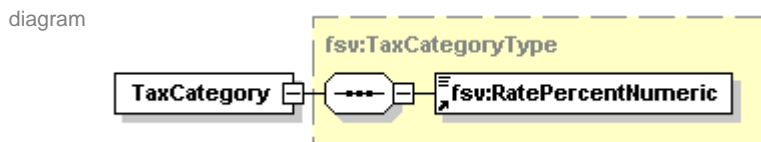

namespace <http://rep.oio.dk/ubl/xml/schemas/0p71/extensible/businessdomain/utilities/2005/10/11/>

type [fsv:TaxCategoryType](#)

properties content complex

children [fsv:RatePercentNumeric](#)

used by complexType [ItemType](#)

source `<xsd:element name="TaxCategory" type="fsv:TaxCategoryType"/>`

## element TaxEnergyAmount

diagram

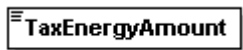

namespace <http://rep.oio.dk/ubl/xml/schemas/0p71/extensible/businessdomain/utilities/2005/10/11/>

type [fsv:AmountType](#)

properties content complex

used by complexType [EnergyTaxInformationDetailType](#)

attributes	Name	Type	Use	Default	Fixed	Annotation
	currencyID	xsd:string	optional	DKK		

source `<xsd:element name="TaxEnergyAmount" type="fsv:AmountType"/>`

## element TaxEnergyBalanceAmount

diagram



namespace <http://rep.oio.dk/ubl/xml/schemas/0p71/extensible/businessdomain/utilities/2005/10/11/>

type [fsv:AmountType](#)

properties content complex

used by complexType [EnergyTaxInformationDetailType](#)

attributes	Name	Type	Use	Default	Fixed	Annotation
	currencyID	xsd:string	optional	DKK		

source `<xsd:element name="TaxEnergyBalanceAmount" type="fsv:AmountType"/>`

## element TaxEnergyOnAccountAmount

diagram

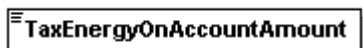

namespace <http://rep.oio.dk/ubl/xml/schemas/0p71/extensible/businessdomain/utilities/2005/10/11/>

type [fsv:AmountType](#)

properties content complex

used by complexType [EnergyTaxInformationDetailType](#)

attributes	Name	Type	Use	Default	Fixed	Annotation
	currencyID	xsd:string	optional	DKK		

source `<xsd:element name="TaxEnergyOnAccountAmount" type="fsv:AmountType"/>`

## element TaxExclusiveTotalAmount

diagram

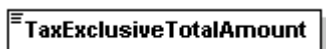

namespace <http://rep.oio.dk/ubl/xml/schemas/0p71/extensible/businessdomain/utilities/2005/10/11/>

type [fsv:AmountType](#)

properties content complex

attributes	Name	Type	Use	Default	Fixed	Annotation
	currencyID	xsd:string	optional	DKK		

source `<xsd:element name="TaxExclusiveTotalAmount" type="fsv:AmountType"/>`

## element TaxInclusiveTotalAmount

diagram



namespace <http://rep.oio.dk/ubl/xml/schemas/0p71/extensible/businessdomain/utilities/2005/10/11/>

type [fsv:AmountType](#)

properties content complex

attributes	Name	Type	Use	Default	Fixed	Annotation
	currencyID	xsd:string	optional	DKK		

source `<xsd:element name="TaxInclusiveTotalAmount" type="fsv:AmountType"/>`

## element TaxTotalAmount

diagram



namespace <http://rep.oio.dk/ubl/xml/schemas/0p71/extensible/businessdomain/utilities/2005/10/11/>

type [fsv:AmountType](#)

properties content complex

used by complexType [DeliveryTaxInformationType](#)

attributes	Name	Type	Use	Default	Fixed	Annotation
	currencyID	xsd:string	optional	DKK		

source `<xsd:element name="TaxTotalAmount" type="fsv:AmountType"/>`

## element TaxTypeCode

diagram

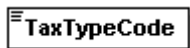

namespace <http://rep.oio.dk/ubl/xml/schemas/0p71/extensible/businessdomain/utilities/2005/10/11/>

type **xsd:string**

properties content simple

used by complexTypes [UtilitySubTaxTotalType](#) [UtilityTaxTotalType](#)

source `<xsd:element name="TaxTypeCode" type="xsd:string"/>`

## element Text

diagram

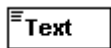

namespace <http://rep.oio.dk/ubl/xml/schemas/0p71/extensible/businessdomain/utilities/2005/10/11/>

type **xsd:string**

properties content simple

used by complexTypes [OnAccountMainTextType](#) [OnAccountPaymentsTextType](#)

source `<xsd:element name="Text" type="xsd:string"/>`

## element **ToBePaidTotalAmount**

diagram

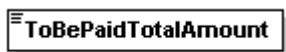

namespace <http://rep.oio.dk/ubl/xml/schemas/0p71/extensible/businessdomain/utilities/2005/10/11/>

type [fsv:AmountType](#)

properties content complex

used by complexTypes [UtilityLegalTotalsType](#) [UtilitySubLegalTotalsType](#)

attributes	Name	Type	Use	Default	Fixed	Annotation
	currencyID	<b>xsd:string</b>	optional	DKK		

source `<xsd:element name="ToBePaidTotalAmount" type="fsv:AmountType"/>`

## element **TotalDeliveredQuantity**

diagram



namespace <http://rep.oio.dk/ubl/xml/schemas/0p71/extensible/businessdomain/utilities/2005/10/11/>

type [fsv:QuantityType](#)

properties content complex

used by complexType [DeliveryMeterInformationType](#)

attributes	Name	Type	Use	Default	Fixed	Annotation
	quantityUnitCode	<b>xsd:string</b>	required			

source `<xsd:element name="TotalDeliveredQuantity" type="fsv:QuantityType"/>`

## element **Type**

diagram

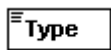

namespace <http://rep.oio.dk/ubl/xml/schemas/0p71/extensible/businessdomain/utilities/2005/10/11/>

type **xsd:string**

properties content simple

used by complexTypes [MainSubscriberIDType](#) [PartyIdentificationType](#)

source `<xsd:element name="Type" type="xsd:string"/>`

element **UtilityInvoice**

diagram

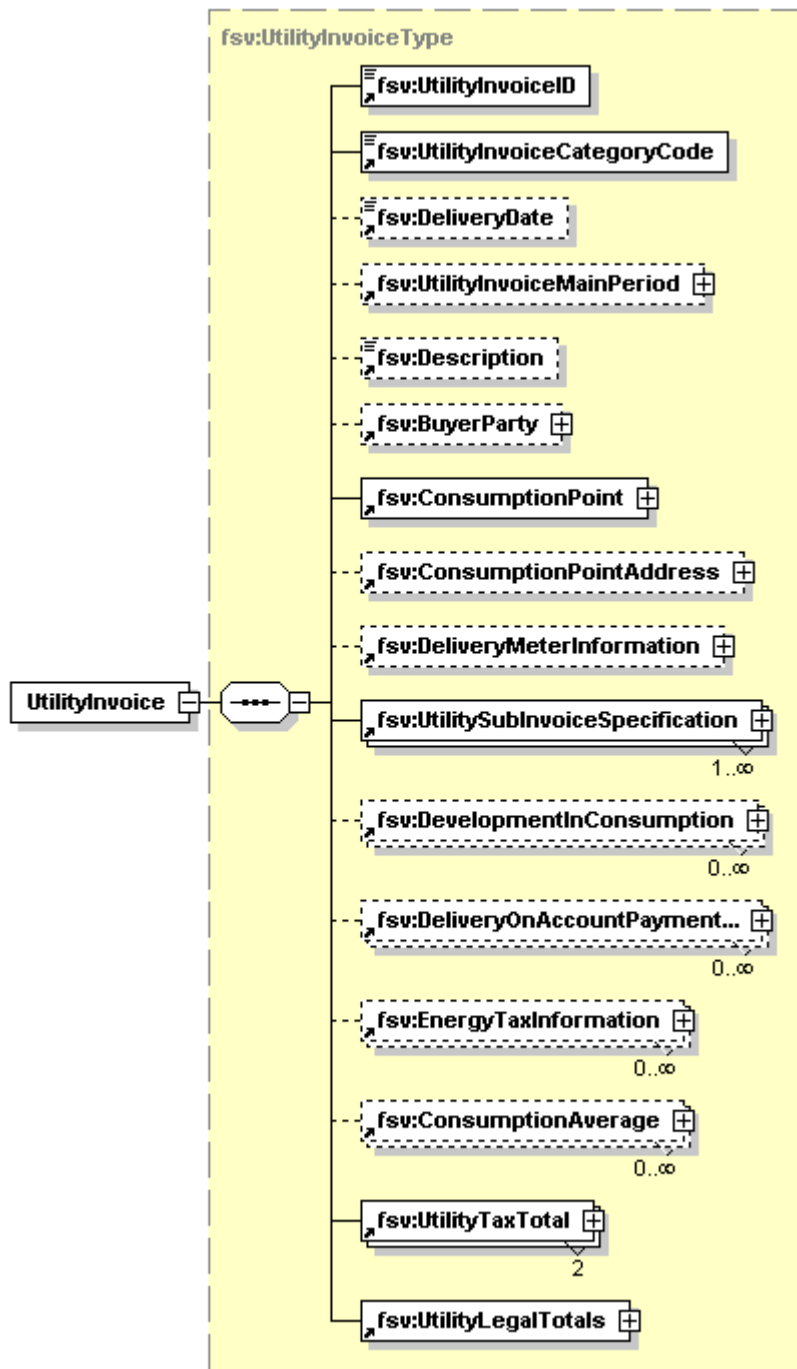

namespace <http://rep.oio.dk/ubl/xml/schemas/0p71/extensible/businessdomain/utilities/2005/10/11/>

type [fsv:UtilityInvoiceType](#)

properties content complex

children [fsv:UtilityInvoiceID](#) [fsv:UtilityInvoiceCategoryCode](#) [fsv:DeliveryDate](#) [fsv:UtilityInvoiceMainPeriod](#) [fsv:Description](#) [fsv:BuyerParty](#) [fsv:ConsumptionPoint](#) [fsv:ConsumptionPointAddress](#) [fsv:DeliveryMeterInformation](#) [fsv:UtilitySubInvoiceSpecification](#) [fsv:DevelopmentInConsumption](#) [fsv:DeliveryOnAccountPaymentSchedule](#) [fsv:EnergyTaxInformation](#) [fsv:ConsumptionAverage](#) [fsv:UtilityTaxTotal](#) [fsv:UtilityLegalTotals](#)

used by complexType [FSVType](#)

source `<xsd:element name="UtilityInvoice" type="fsv:UtilityInvoiceType"/>`

### element **UtilityInvoiceCategoryCode**



namespace <http://rep.oio.dk/ubl/xml/schemas/0p71/extensible/businessdomain/utilities/2005/10/11/>

type **xsd:string**

properties content simple

used by complexType [UtilityInvoiceType](#)

source `<xsd:element name="UtilityInvoiceCategoryCode" type="xsd:string"/>`

### element **UtilityInvoiceID**

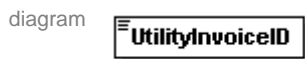

namespace <http://rep.oio.dk/ubl/xml/schemas/0p71/extensible/businessdomain/utilities/2005/10/11/>

type **xsd:string**

properties content simple

used by complexType [UtilityInvoiceType](#)

source `<xsd:element name="UtilityInvoiceID" type="xsd:string"/>`

### element **UtilityInvoiceMainPeriod**

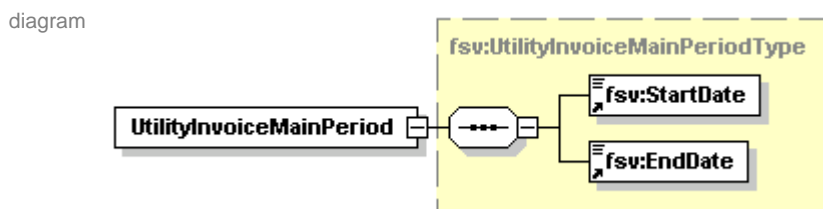

namespace <http://rep.oio.dk/ubl/xml/schemas/0p71/extensible/businessdomain/utilities/2005/10/11/>

type [fsv:UtilityInvoiceMainPeriodType](#)

properties content complex

children [fsv:StartDate](#) [fsv:EndDate](#)

used by complexType [UtilityInvoiceType](#)

source `<xsd:element name="UtilityInvoiceMainPeriod" type="fsv:UtilityInvoiceMainPeriodType"/>`

## element **UtilityLegalTotals**

diagram

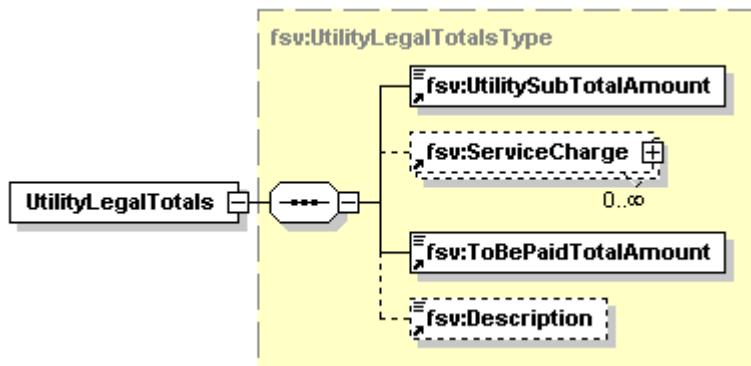

namespace <http://rep.oio.dk/ubl/xml/schemas/0p71/extensible/businessdomain/utilities/2005/10/11/>

type [fsv:UtilityLegalTotalsType](#)

properties content complex

children [fsv:UtilitySubTotalAmount](#) [fsv:ServiceCharge](#) [fsv:ToBePaidTotalAmount](#) [fsv:Description](#)

used by complexType [UtilityInvoiceType](#)

source `<xsd:element name="UtilityLegalTotals" type="fsv:UtilityLegalTotalsType"/>`

## element **UtilitySubInvoiceDetails**

diagram

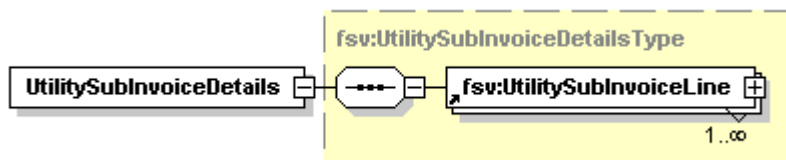

namespace <http://rep.oio.dk/ubl/xml/schemas/0p71/extensible/businessdomain/utilities/2005/10/11/>

type [fsv:UtilitySubInvoiceDetailsType](#)

properties content complex

children [fsv:UtilitySubInvoiceLine](#)

used by complexType [UtilitySubInvoiceSpecificationType](#)

source `<xsd:element name="UtilitySubInvoiceDetails" type="fsv:UtilitySubInvoiceDetailsType"/>`

## element **UtilitySubInvoiceHeader**

diagram

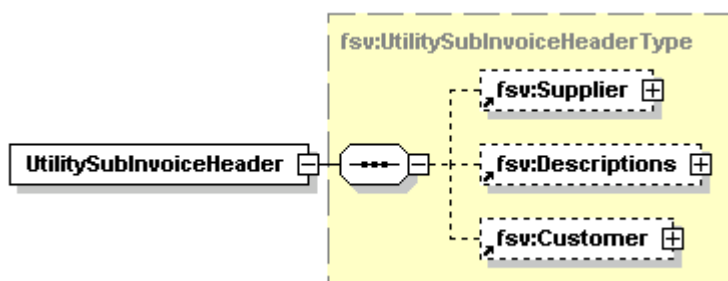

namespace <http://rep.oio.dk/ubl/xml/schemas/0p71/extensible/businessdomain/utilities/2005/10/11/>

type [fsv:UtilitySubInvoiceHeaderType](#)  
 properties content complex  
 children [fsv:Supplier](#) [fsv:Descriptions](#) [fsv:Customer](#)  
 used by complexType [UtilitySubInvoiceSpecificationType](#)  
 source `<xsd:element name="UtilitySubInvoiceHeader" type="fsv:UtilitySubInvoiceHeaderType"/>`

## element UtilitySubInvoiceLine

diagram

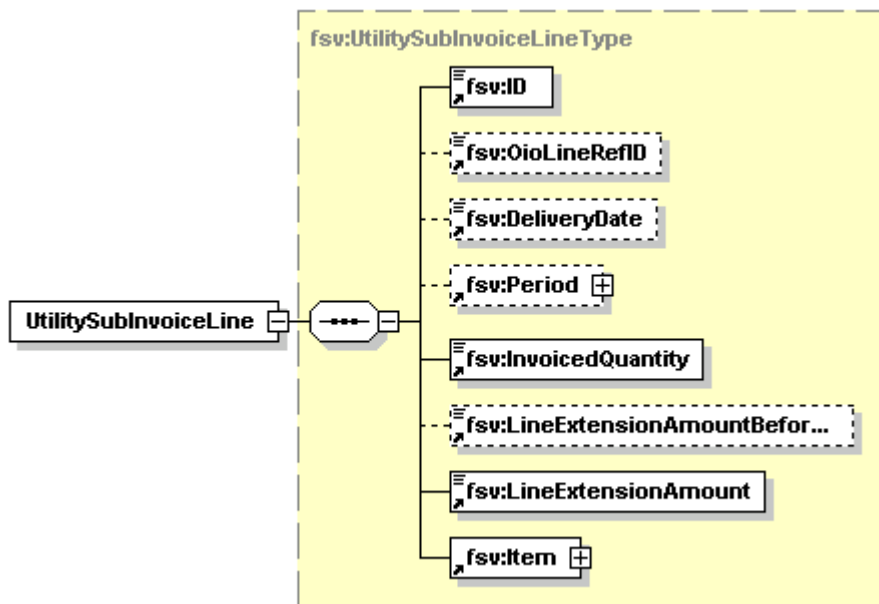

namespace <http://rep.oio.dk/ubl/xml/schemas/0p71/extensible/businessdomain/utilities/2005/10/11/>

type [fsv:UtilitySubInvoiceLineType](#)  
 properties content complex  
 children [fsv:ID](#) [fsv:OioLineRefID](#) [fsv:DeliveryDate](#) [fsv:Period](#) [fsv:InvoicedQuantity](#) [fsv:LineExtensionAmountBeforeDiscount](#) [fsv:LineExtensionAmount](#) [fsv:Item](#)  
 used by complexType [UtilitySubInvoiceDetailsType](#)  
 source `<xsd:element name="UtilitySubInvoiceLine" type="fsv:UtilitySubInvoiceLineType"/>`

## element UtilitySubInvoiceSpecification

diagram

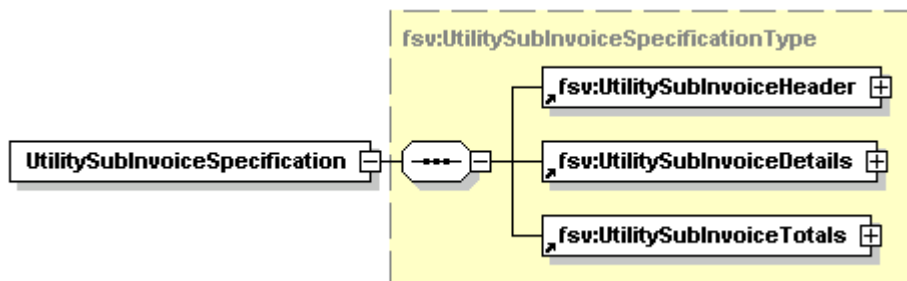

namespace <http://rep.oio.dk/ubl/xml/schemas/0p71/extensible/businessdomain/utilities/2005/10/11/>

type [fsv:UtilitySubInvoiceSpecificationType](#)  
 properties content complex



children [fsv:UtilitySubInvoiceHeader](#) [fsv:UtilitySubInvoiceDetails](#) [fsv:UtilitySubInvoiceTotals](#)

used by complexType [UtilityInvoiceType](#)

source `<xsd:element name="UtilitySubInvoiceSpecification" type="fsv:UtilitySubInvoiceSpecificationType"/>`

## element **UtilitySubInvoiceTotals**

diagram

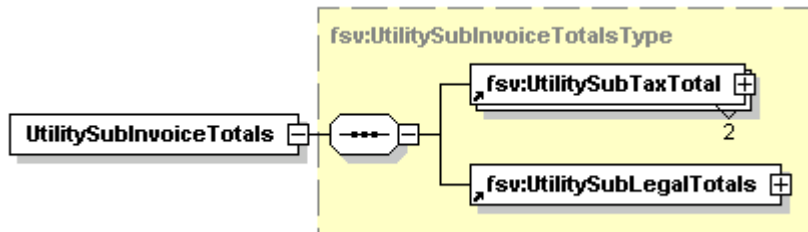

namespace <http://rep.oiio.dk/ubl/xml/schemas/0p71/extensible/businessdomain/utilities/2005/10/11/>

type [fsv:UtilitySubInvoiceTotalsType](#)

properties content complex

children [fsv:UtilitySubTaxTotal](#) [fsv:UtilitySubLegalTotals](#)

used by complexType [UtilitySubInvoiceSpecificationType](#)

source `<xsd:element name="UtilitySubInvoiceTotals" type="fsv:UtilitySubInvoiceTotalsType"/>`

## element **UtilitySubLegalTotals**

diagram

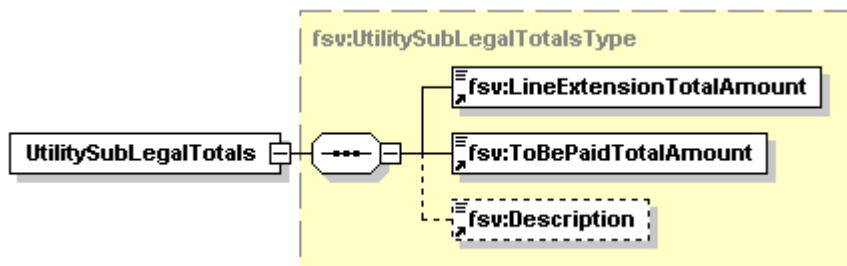

namespace <http://rep.oiio.dk/ubl/xml/schemas/0p71/extensible/businessdomain/utilities/2005/10/11/>

type [fsv:UtilitySubLegalTotalsType](#)

properties content complex

children [fsv:LineExtensionTotalAmount](#) [fsv:ToBePaidTotalAmount](#) [fsv:Description](#)

used by complexType [UtilitySubInvoiceTotalsType](#)

source `<xsd:element name="UtilitySubLegalTotals" type="fsv:UtilitySubLegalTotalsType"/>`

## element UtilitySubTaxTotal

diagram

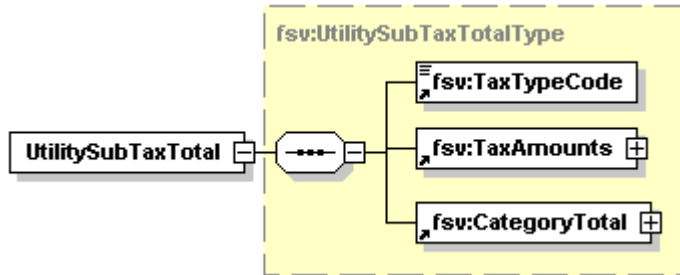

namespace <http://rep.oio.dk/ubl/xml/schemas/0p71/extensible/businessdomain/utilities/2005/10/11/>

type [fsv:UtilitySubTaxTotalType](#)

properties content complex

children [fsv:TaxTypeCode](#) [fsv:TaxAmounts](#) [fsv:CategoryTotal](#)

used by complexType [UtilitySubInvoiceTotalsType](#)

source `<xsd:element name="UtilitySubTaxTotal" type="fsv:UtilitySubTaxTotalType"/>`

## element UtilitySubTotalAmount

diagram



namespace <http://rep.oio.dk/ubl/xml/schemas/0p71/extensible/businessdomain/utilities/2005/10/11/>

type [fsv:AmountType](#)

properties content complex

used by complexType [UtilityLegalTotalsType](#)

attributes	Name	Type	Use	Default	Fixed	Annotation
	currencyID	<code>xsd:string</code>	optional	DKK		

source `<xsd:element name="UtilitySubTotalAmount" type="fsv:AmountType"/>`

## element UtilityTaxTotal

diagram

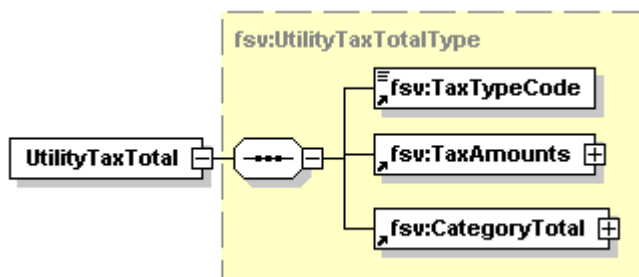

namespace <http://rep.oio.dk/ubl/xml/schemas/0p71/extensible/businessdomain/utilities/2005/10/11/>

type [fsv:UtilityTaxTotalType](#)

properties content complex

children [fsv:TaxTypeCode](#) [fsv:TaxAmounts](#) [fsv:CategoryTotal](#)

used by complexType [UtilityInvoiceType](#)

source `<xsd:element name="UtilityTaxTotal" type="fsv:UtilityTaxTotalType"/>`

## complexType **AdditionalSpecificationType**

diagram

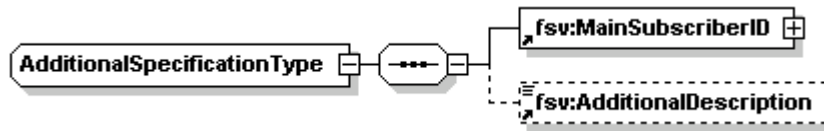

namespace <http://rep.oiio.dk/ubl/xml/schemas/0p71/extensible/businessdomain/utilities/2005/10/11/>

children [fsv:MainSubscriberID](#) [fsv:AdditionalDescription](#)

used by element [AdditionalSpecification](#)

```
source <xsd:complexType name="AdditionalSpecificationType">
  <xsd:sequence>
    <xsd:element ref="fsv:MainSubscriberID"/>
    <xsd:element ref="fsv:AdditionalDescription" minOccurs="0"/>
  </xsd:sequence>
</xsd:complexType>
```

## complexType **AddressLinesType**

diagram

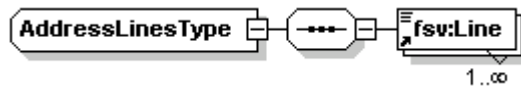

namespace <http://rep.oiio.dk/ubl/xml/schemas/0p71/extensible/businessdomain/utilities/2005/10/11/>

children [fsv:Line](#)

used by element [AddressLines](#)

```
source <xsd:complexType name="AddressLinesType">
  <xsd:sequence>
    <xsd:element ref="fsv:Line" maxOccurs="unbounded"/>
  </xsd:sequence>
</xsd:complexType>
```

## complexType **AmountType**

diagram



namespace <http://rep.oiio.dk/ubl/xml/schemas/0p71/extensible/businessdomain/utilities/2005/10/11/>

type extension of **xsd:decimal**

properties base `xsd:decimal`

used by elements [Amount](#) [AverageAmount](#) [Balance](#) [LineExtensionAmount](#) [LineExtensionAmountBeforeDiscount](#) [LineExtensionTotalAmount](#) [OnAccount](#) [PriceAmount](#) [ServiceAmount](#) [TaxableAmount](#) [TaxAmount](#) [TaxEnergyAmount](#) [TaxEnergyBalanceAmount](#) [TaxEnergyOnAccountAmount](#) [TaxExclusiveTotalAmount](#) [TaxInclusiveTotalAmount](#) [TaxTotalAmount](#) [ToBePaidTotalAmount](#) [UtilitySubTotalAmount](#)

attributes	Name	Type	Use	Default	Fixed	Annotation
	currencyID	<b>xsd:string</b>	optional	DKK		

```
source <xsd:complexType name="AmountType">
  <xsd:simpleContent>
    <xsd:extension base="xsd:decimal">
      <xsd:attribute name="currencyID" type="xsd:string" use="optional" default="DKK"/>
    </xsd:extension>
  </xsd:simpleContent>
</xsd:complexType>
```

## complexType BasePriceType

diagram



namespace <http://rep.oiio.dk/ubl/xml/schemas/0p71/extensible/businessdomain/utilities/2005/10/11/>

children [fsv:PriceAmount](#)

used by element [BasePrice](#)

```
source <xsd:complexType name="BasePriceType">
  <xsd:sequence>
    <xsd:element ref="fsv:PriceAmount"/>
  </xsd:sequence>
</xsd:complexType>
```

## complexType BuyerPartyType

diagram

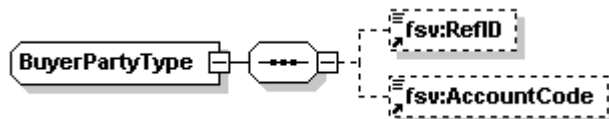

namespace <http://rep.oiio.dk/ubl/xml/schemas/0p71/extensible/businessdomain/utilities/2005/10/11/>

children [fsv:RefID](#) [fsv:AccountCode](#)

used by element [BuyerParty](#)

```
source <xsd:complexType name="BuyerPartyType">
  <xsd:sequence>
    <xsd:element ref="fsv:RefID" minOccurs="0"/>
    <xsd:element ref="fsv:AccountCode" minOccurs="0"/>
  </xsd:sequence>
</xsd:complexType>
```

## complexType CategoryTotalType

diagram

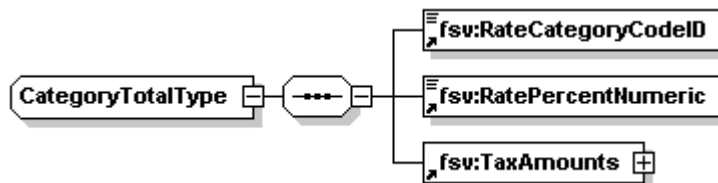

namespace <http://rep.oiio.dk/ubl/xml/schemas/0p71/extensible/businessdomain/utilities/2005/10/11/>

children [fsv:RateCategoryCodeID](#) [fsv:RatePercentNumeric](#) [fsv:TaxAmounts](#)

used by element [CategoryTotal](#)

```
source <xsd:complexType name="CategoryTotalType">
  <xsd:sequence>
    <xsd:element ref="fsv:RateCategoryCodeID"/>
    <xsd:element ref="fsv:RatePercentNumeric"/>
    <xsd:element ref="fsv:TaxAmounts"/>
  </xsd:sequence>
</xsd:complexType>
```

## complexType ConsumptionAverageType

diagram

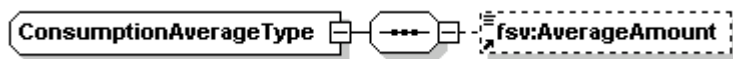

namespace <http://rep.oio.dk/ubl/xml/schemas/0p71/extensible/businessdomain/utilities/2005/10/11/>

children [fsv:AverageAmount](#)

used by element [ConsumptionAverage](#)

```
source <xsd:complexType name="ConsumptionAverageType">
  <xsd:sequence>
    <xsd:element ref="fsv:AverageAmount" minOccurs="0"/>
  </xsd:sequence>
</xsd:complexType>
```

## complexType ConsumptionPointAddressType

diagram

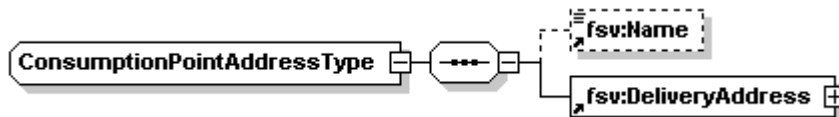

namespace <http://rep.oio.dk/ubl/xml/schemas/0p71/extensible/businessdomain/utilities/2005/10/11/>

children [fsv:Name](#) [fsv:DeliveryAddress](#)

used by element [ConsumptionPointAddress](#)

```
source <xsd:complexType name="ConsumptionPointAddressType">
  <xsd:sequence>
    <xsd:element ref="fsv:Name" minOccurs="0"/>
    <xsd:element ref="fsv:DeliveryAddress"/>
  </xsd:sequence>
</xsd:complexType>
```

## complexType ConsumptionPointType

diagram

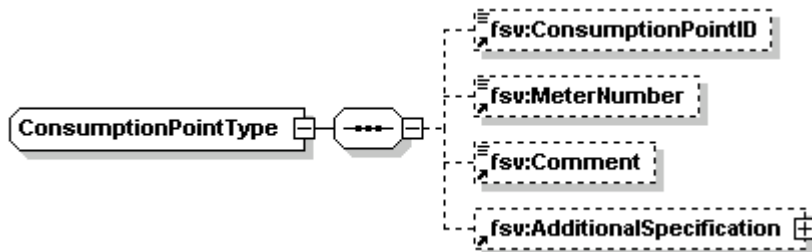

namespace <http://rep.oio.dk/ubl/xml/schemas/0p71/extensible/businessdomain/utilities/2005/10/11/>

children [fsv:ConsumptionPointID](#) [fsv:MeterNumber](#) [fsv:Comment](#) [fsv:AdditionalSpecification](#)

used by element [ConsumptionPoint](#)

```
source <xsd:complexType name="ConsumptionPointType">
  <xsd:sequence>
    <xsd:element ref="fsv:ConsumptionPointID" minOccurs="0"/>
    <xsd:element ref="fsv:MeterNumber" minOccurs="0"/>
    <xsd:element ref="fsv:Comment" minOccurs="0"/>
    <xsd:element ref="fsv:AdditionalSpecification" minOccurs="0"/>
  </xsd:sequence>
</xsd:complexType>
```

## complexType ContractType

diagram



namespace <http://rep.oio.dk/ubl/xml/schemas/0p71/extensible/businessdomain/utilities/2005/10/11/>

children [fsv:ContractID](#)

used by element [Contract](#)

```
<xsd:complexType name="ContractType">
  <xsd:sequence>
    <xsd:element ref="fsv:ContractID"/>
  </xsd:sequence>
</xsd:complexType>
```

## complexType CountryType

diagram



namespace <http://rep.oio.dk/ubl/xml/schemas/0p71/extensible/businessdomain/utilities/2005/10/11/>

children [fsv:Code](#)

used by element [Country](#)

```
<xsd:complexType name="CountryType">
  <xsd:sequence>
    <xsd:element ref="fsv:Code"/>
  </xsd:sequence>
</xsd:complexType>
```

## complexType CustomerType

diagram

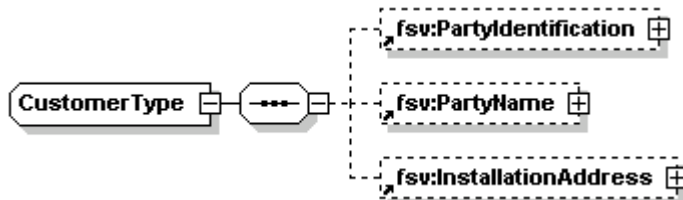

namespace <http://rep.oio.dk/ubl/xml/schemas/0p71/extensible/businessdomain/utilities/2005/10/11/>

children [fsv:PartyIdentification](#) [fsv:PartyName](#) [fsv:InstallationAddress](#)

used by element [Customer](#)

```
<xsd:complexType name="CustomerType">
  <xsd:sequence>
    <xsd:element ref="fsv:PartyIdentification" minOccurs="0"/>
    <xsd:element ref="fsv:PartyName" minOccurs="0"/>
    <xsd:element ref="fsv:InstallationAddress" minOccurs="0"/>
  </xsd:sequence>
</xsd:complexType>
```

## complexType DeliveredQuantityBasedOnMeterReadingsType

diagram

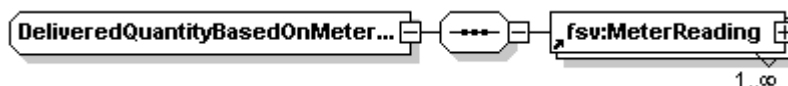

namespace <http://rep.oio.dk/ubl/xml/schemas/Op71/extensible/businessdomain/utilities/2005/10/11/>

children [fsv:MeterReading](#)

used by element [DeliveredQuantityBasedOnMeterReadings](#)

```
source <xsd:complexType name="DeliveredQuantityBasedOnMeterReadingsType">
  <xsd:sequence>
    <xsd:element ref="fsv:MeterReading" maxOccurs="unbounded"/>
  </xsd:sequence>
</xsd:complexType>
```

## complexType **DeliveryAddressType**

diagram

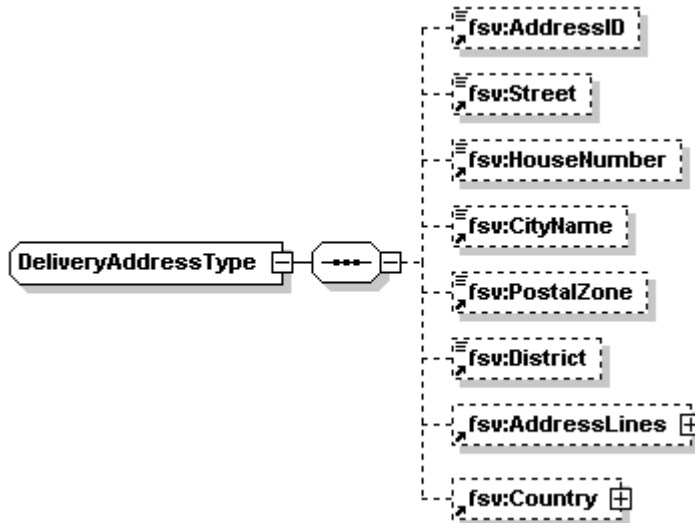

namespace <http://rep.oio.dk/ubl/xml/schemas/Op71/extensible/businessdomain/utilities/2005/10/11/>

children [fsv:AddressID](#) [fsv:Street](#) [fsv:HouseNumber](#) [fsv:CityName](#) [fsv:PostalZone](#) [fsv:District](#) [fsv:AddressLines](#) [fsv:Country](#)

used by element [DeliveryAddress](#)

```
source <xsd:complexType name="DeliveryAddressType">
  <xsd:sequence>
    <xsd:element ref="fsv:AddressID" minOccurs="0"/>
    <xsd:element ref="fsv:Street" minOccurs="0"/>
    <xsd:element ref="fsv:HouseNumber" minOccurs="0"/>
    <xsd:element ref="fsv:CityName" minOccurs="0"/>
    <xsd:element ref="fsv:PostalZone" minOccurs="0"/>
    <xsd:element ref="fsv:District" minOccurs="0"/>
    <xsd:element ref="fsv:AddressLines" minOccurs="0"/>
    <xsd:element ref="fsv:Country" minOccurs="0"/>
  </xsd:sequence>
</xsd:complexType>
```

## complexType **DeliveryMeterInformationType**

diagram

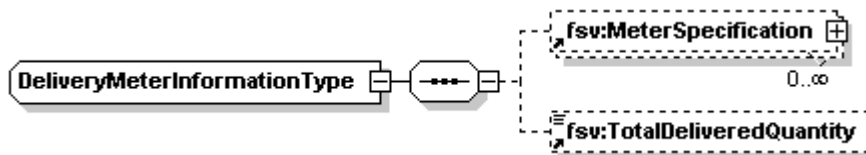

namespace <http://rep.oio.dk/ubl/xml/schemas/Op71/extensible/businessdomain/utilities/2005/10/11/>

children [fsv:MeterSpecification](#) [fsv:TotalDeliveredQuantity](#)

used by element [DeliveryMeterInformation](#)

```
source <xsd:complexType name="DeliveryMeterInformationType">
  <xsd:sequence>
    <xsd:element ref="fsv:MeterSpecification" minOccurs="0" maxOccurs="unbounded"/>
    <xsd:element ref="fsv:TotalDeliveredQuantity" minOccurs="0"/>
  </xsd:sequence>
</xsd:complexType>
```

## complexType **DeliveryOnAccountPaymentScheduleType**

diagram

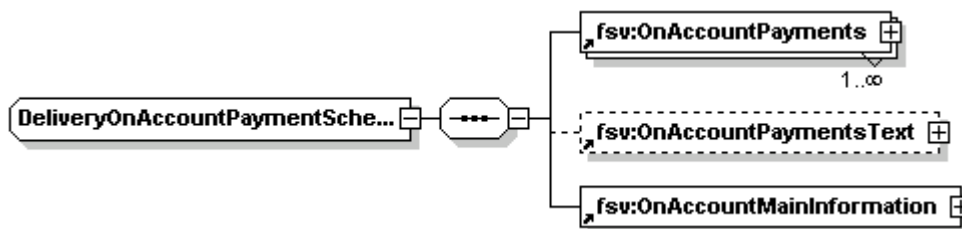

namespace <http://rep.oio.dk/ubl/xml/schemas/0p71/extensible/businessdomain/utilities/2005/10/11/>

children [fsv:OnAccountPayments](#) [fsv:OnAccountPaymentsText](#) [fsv:OnAccountMainInformation](#)

used by element [DeliveryOnAccountPaymentSchedule](#)

```
source <xsd:complexType name="DeliveryOnAccountPaymentScheduleType">
  <xsd:sequence>
    <xsd:element ref="fsv:OnAccountPayments" maxOccurs="unbounded"/>
    <xsd:element ref="fsv:OnAccountPaymentsText" minOccurs="0"/>
    <xsd:element ref="fsv:OnAccountMainInformation"/>
  </xsd:sequence>
</xsd:complexType>
```

## complexType **DeliveryTaxInformationType**

diagram

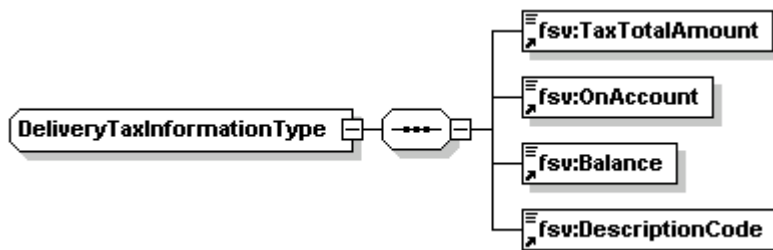

namespace <http://rep.oio.dk/ubl/xml/schemas/0p71/extensible/businessdomain/utilities/2005/10/11/>

children [fsv:TaxTotalAmount](#) [fsv:OnAccount](#) [fsv:Balance](#) [fsv:DescriptionCode](#)

used by element [DeliveryTaxInformation](#)

```
source <xsd:complexType name="DeliveryTaxInformationType">
  <xsd:sequence>
    <xsd:element ref="fsv:TaxTotalAmount"/>
    <xsd:element ref="fsv:OnAccount"/>
    <xsd:element ref="fsv:Balance"/>
    <xsd:element ref="fsv:DescriptionCode"/>
  </xsd:sequence>
</xsd:complexType>
```



## complexType DescriptionsType

diagram

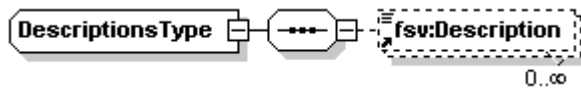

namespace <http://rep.oio.dk/ubl/xml/schemas/0p71/extensible/businessdomain/utilities/2005/10/11/>

children [fsv:Description](#)

used by element [Descriptions](#)

```
<xsd:complexType name="DescriptionsType">
  <xsd:sequence>
    <xsd:element ref="fsv:Description" minOccurs="0" maxOccurs="unbounded"/>
  </xsd:sequence>
</xsd:complexType>
```

## complexType DevelopmentInConsumptionType

diagram

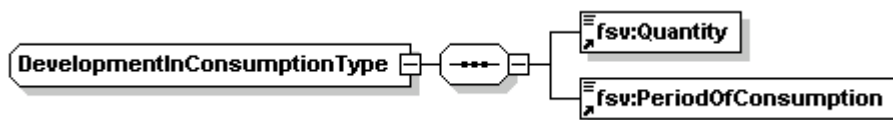

namespace <http://rep.oio.dk/ubl/xml/schemas/0p71/extensible/businessdomain/utilities/2005/10/11/>

children [fsv:Quantity](#) [fsv:PeriodOfConsumption](#)

used by element [DevelopmentInConsumption](#)

```
<xsd:complexType name="DevelopmentInConsumptionType">
  <xsd:sequence>
    <xsd:element ref="fsv:Quantity"/>
    <xsd:element ref="fsv:PeriodOfConsumption"/>
  </xsd:sequence>
</xsd:complexType>
```

## complexType DiscountType

diagram

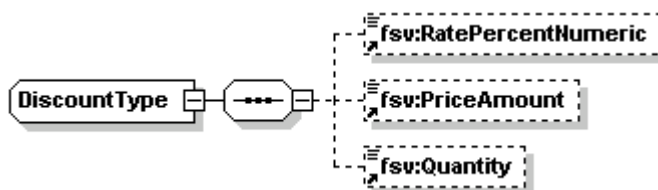

namespace <http://rep.oio.dk/ubl/xml/schemas/0p71/extensible/businessdomain/utilities/2005/10/11/>

children [fsv:RatePercentNumeric](#) [fsv:PriceAmount](#) [fsv:Quantity](#)

used by element [Discount](#)

```
<xsd:complexType name="DiscountType">
  <xsd:sequence>
    <xsd:element ref="fsv:RatePercentNumeric" minOccurs="0"/>
    <xsd:element ref="fsv:PriceAmount" minOccurs="0"/>
    <xsd:element ref="fsv:Quantity" minOccurs="0"/>
  </xsd:sequence>
</xsd:complexType>
```

## complexType EnergyTaxInformationDetailType

diagram

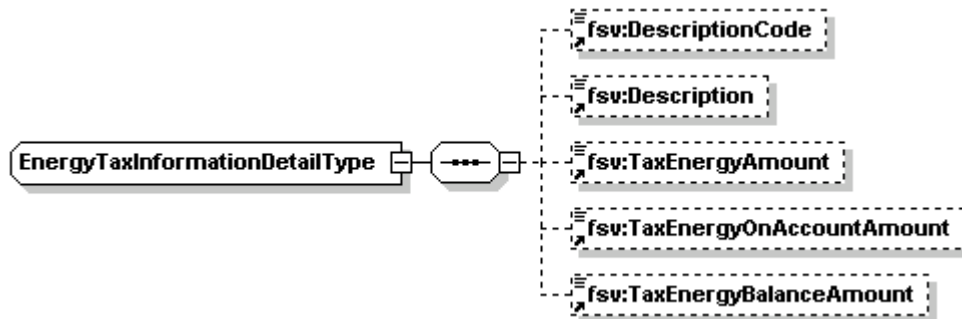

namespace <http://rep.oio.dk/ubl/xml/schemas/0p71/extensible/businessdomain/utilities/2005/10/11/>

children [fsv:DescriptionCode](#) [fsv:Description](#) [fsv:TaxEnergyAmount](#) [fsv:TaxEnergyOnAccountAmount](#) [fsv:TaxEnergyBalanceAmount](#)

used by element [EnergyTaxInformationDetail](#)

```
<xsd:complexType name="EnergyTaxInformationDetailType">
  <xsd:sequence>
    <xsd:element ref="fsv:DescriptionCode" minOccurs="0"/>
    <xsd:element ref="fsv:Description" minOccurs="0"/>
    <xsd:element ref="fsv:TaxEnergyAmount" minOccurs="0"/>
    <xsd:element ref="fsv:TaxEnergyOnAccountAmount" minOccurs="0"/>
    <xsd:element ref="fsv:TaxEnergyBalanceAmount" minOccurs="0"/>
  </xsd:sequence>
</xsd:complexType>
```

## complexType EnergyTaxInformationType

diagram

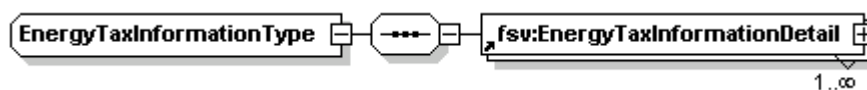

namespace <http://rep.oio.dk/ubl/xml/schemas/0p71/extensible/businessdomain/utilities/2005/10/11/>

children [fsv:EnergyTaxInformationDetail](#)

used by element [EnergyTaxInformation](#)

```
<xsd:complexType name="EnergyTaxInformationType">
  <xsd:sequence>
    <xsd:element ref="fsv:EnergyTaxInformationDetail" maxOccurs="unbounded"/>
  </xsd:sequence>
</xsd:complexType>
```

## complexType FSVType

diagram

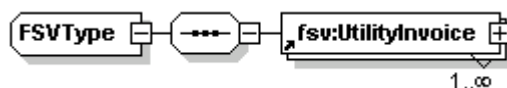

namespace <http://rep.oio.dk/ubl/xml/schemas/0p71/extensible/businessdomain/utilities/2005/10/11/>

children [fsv:UtilityInvoice](#)

used by element [FSV](#)

```
<xsd:complexType name="FSVType">
  <xsd:sequence>
    <xsd:element ref="fsv:UtilityInvoice" maxOccurs="unbounded"/>
  </xsd:sequence>
```

</xsd:complexType>

## complexType InstallationAddressType

diagram

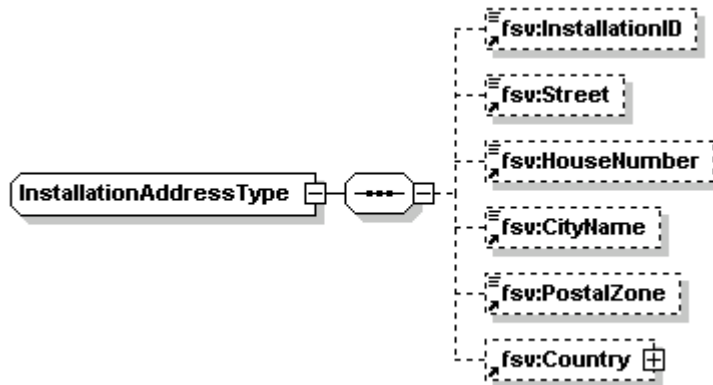

namespace <http://rep.oiio.dk/ubl/xml/schemas/0p71/extensible/businessdomain/utilities/2005/10/11/>

children [fsv:InstallationID](#) [fsv:Street](#) [fsv:HouseNumber](#) [fsv:CityName](#) [fsv:PostalZone](#) [fsv:Country](#)

used by element [InstallationAddress](#)

```
source <xsd:complexType name="InstallationAddressType">
  <xsd:sequence>
    <xsd:element ref="fsv:InstallationID" minOccurs="0"/>
    <xsd:element ref="fsv:Street" minOccurs="0"/>
    <xsd:element ref="fsv:HouseNumber" minOccurs="0"/>
    <xsd:element ref="fsv:CityName" minOccurs="0"/>
    <xsd:element ref="fsv:PostalZone" minOccurs="0"/>
    <xsd:element ref="fsv:Country" minOccurs="0"/>
  </xsd:sequence>
</xsd:complexType>
```

## complexType InvoicedPeriodType

diagram

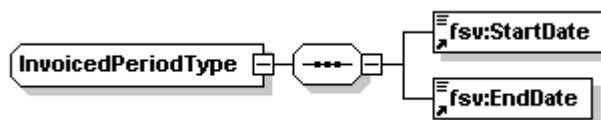

namespace <http://rep.oiio.dk/ubl/xml/schemas/0p71/extensible/businessdomain/utilities/2005/10/11/>

children [fsv:StartDate](#) [fsv:EndDate](#)

used by element [InvoicedPeriod](#)

```
source <xsd:complexType name="InvoicedPeriodType">
  <xsd:sequence>
    <xsd:element ref="fsv:StartDate"/>
    <xsd:element ref="fsv:EndDate"/>
  </xsd:sequence>
</xsd:complexType>
```

## complexType **ItemAddressType**

diagram

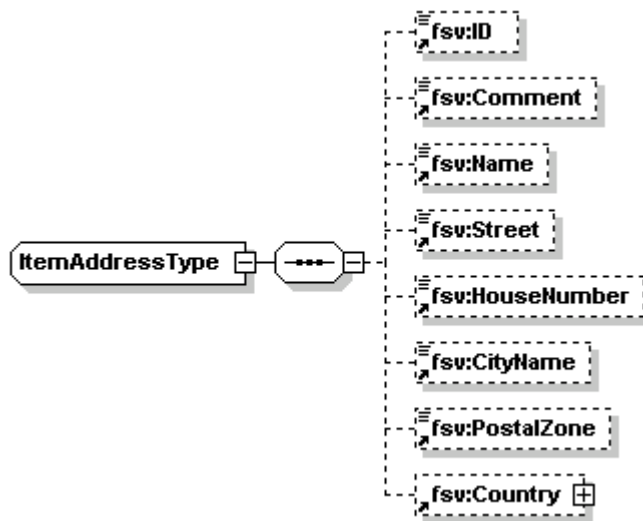

namespace <http://rep.oio.dk/ubl/xml/schemas/0p71/extensible/businessdomain/utilities/2005/10/11/>

children [fsv:ID](#) [fsv:Comment](#) [fsv:Name](#) [fsv:Street](#) [fsv:HouseNumber](#) [fsv:CityName](#) [fsv:PostalZone](#) [fsv:Country](#)

used by element [ItemAddress](#)

```
source <xsd:complexType name="ItemAddressType">
  <xsd:sequence>
    <xsd:element ref="fsv:ID" minOccurs="0"/>
    <xsd:element ref="fsv:Comment" minOccurs="0"/>
    <xsd:element ref="fsv:Name" minOccurs="0"/>
    <xsd:element ref="fsv:Street" minOccurs="0"/>
    <xsd:element ref="fsv:HouseNumber" minOccurs="0"/>
    <xsd:element ref="fsv:CityName" minOccurs="0"/>
    <xsd:element ref="fsv:PostalZone" minOccurs="0"/>
    <xsd:element ref="fsv:Country" minOccurs="0"/>
  </xsd:sequence>
</xsd:complexType>
```

## complexType ItemType

diagram

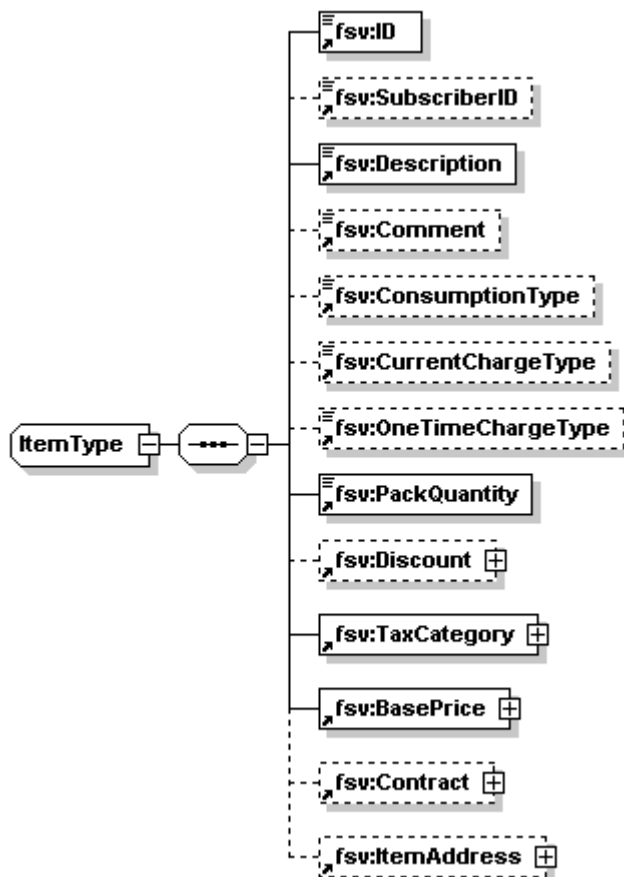

namespace <http://rep.oio.dk/ubl/xml/schemas/0p71/extensible/businessdomain/utilities/2005/10/11/>

children [fsv:ID](#) [fsv:SubscriberID](#) [fsv:Description](#) [fsv:Comment](#) [fsv:ConsumptionType](#) [fsv:CurrentChargeType](#) [fsv:OneTimeChargeType](#) [fsv:PackQuantity](#) [fsv:Discount](#) [fsv:TaxCategory](#) [fsv:BasePrice](#) [fsv:Contract](#) [fsv:ItemAddress](#)

used by element [Item](#)

```
<xsd:complexType name="ItemType">
  <xsd:sequence>
    <xsd:element ref="fsv:ID"/>
    <xsd:element ref="fsv:SubscriberID" minOccurs="0"/>
    <xsd:element ref="fsv:Description"/>
    <xsd:element ref="fsv:Comment" minOccurs="0"/>
    <xsd:element ref="fsv:ConsumptionType" minOccurs="0"/>
    <xsd:element ref="fsv:CurrentChargeType" minOccurs="0"/>
    <xsd:element ref="fsv:OneTimeChargeType" minOccurs="0"/>
    <xsd:element ref="fsv:PackQuantity"/>
    <xsd:element ref="fsv:Discount" minOccurs="0"/>
    <xsd:element ref="fsv:TaxCategory"/>
    <xsd:element ref="fsv:BasePrice"/>
    <xsd:element ref="fsv:Contract" minOccurs="0"/>
    <xsd:element ref="fsv:ItemAddress" minOccurs="0"/>
  </xsd:sequence>
</xsd:complexType>
```

## complexType **MainSubscriberIDType**

diagram

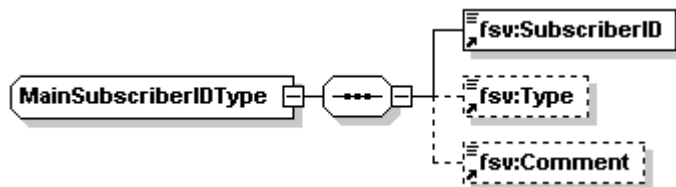

namespace <http://rep.oiio.dk/ubl/xml/schemas/0p71/extensible/businessdomain/utilities/2005/10/11/>

children [fsv:SubscriberID](#) [fsv:Type](#) [fsv:Comment](#)

used by element [MainSubscriberID](#)

```
source <xsd:complexType name="MainSubscriberIDType">
  <xsd:sequence>
    <xsd:element ref="fsv:SubscriberID"/>
    <xsd:element ref="fsv:Type" minOccurs="0"/>
    <xsd:element ref="fsv:Comment" minOccurs="0"/>
  </xsd:sequence>
</xsd:complexType>
```

## complexType **MeteringPointType**

diagram

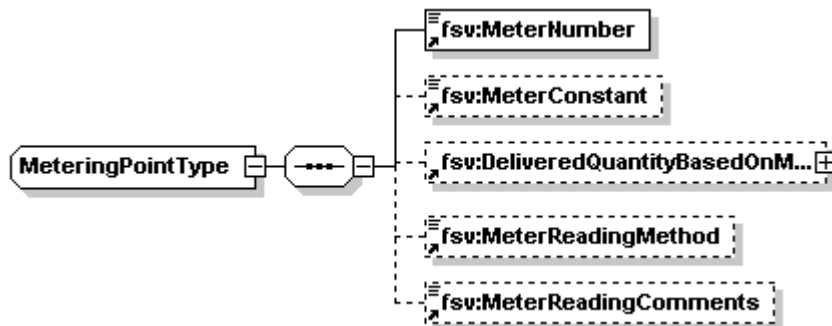

namespace <http://rep.oiio.dk/ubl/xml/schemas/0p71/extensible/businessdomain/utilities/2005/10/11/>

children [fsv:MeterNumber](#) [fsv:MeterConstant](#) [fsv:DeliveredQuantityBasedOnMeterReadings](#) [fsv:MeterReadingMethod](#) [fsv:MeterReadingComments](#)

used by element [MeteringPoint](#)

```
source <xsd:complexType name="MeteringPointType">
  <xsd:sequence>
    <xsd:element ref="fsv:MeterNumber"/>
    <xsd:element ref="fsv:MeterConstant" minOccurs="0"/>
    <xsd:element ref="fsv:DeliveredQuantityBasedOnMeterReadings" minOccurs="0"/>
    <xsd:element ref="fsv:MeterReadingMethod" minOccurs="0"/>
    <xsd:element ref="fsv:MeterReadingComments" minOccurs="0"/>
  </xsd:sequence>
</xsd:complexType>
```

## complexType MeterReadingType

diagram

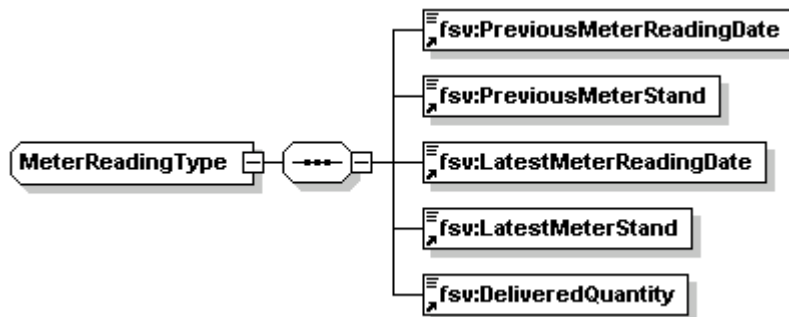

namespace <http://rep.oio.dk/ubl/xml/schemas/0p71/extensible/businessdomain/utilities/2005/10/11/>

children [fsv:PreviousMeterReadingDate](#) [fsv:PreviousMeterStand](#) [fsv:LatestMeterReadingDate](#) [fsv:LatestMeterStand](#) [fsv:DeliveredQuantity](#)

used by element [MeterReading](#)

```
<xsd:complexType name="MeterReadingType">
  <xsd:sequence>
    <xsd:element ref="fsv:PreviousMeterReadingDate"/>
    <xsd:element ref="fsv:PreviousMeterStand"/>
    <xsd:element ref="fsv:LatestMeterReadingDate"/>
    <xsd:element ref="fsv:LatestMeterStand"/>
    <xsd:element ref="fsv:DeliveredQuantity"/>
  </xsd:sequence>
</xsd:complexType>
```

## complexType MeterSpecificationType

diagram

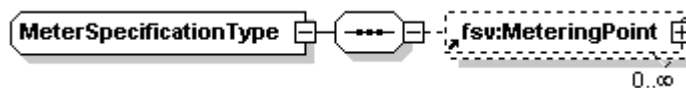

namespace <http://rep.oio.dk/ubl/xml/schemas/0p71/extensible/businessdomain/utilities/2005/10/11/>

children [fsv:MeteringPoint](#)

used by element [MeterSpecification](#)

```
<xsd:complexType name="MeterSpecificationType">
  <xsd:sequence>
    <xsd:element ref="fsv:MeteringPoint" minOccurs="0" maxOccurs="unbounded"/>
  </xsd:sequence>
</xsd:complexType>
```

## complexType OnAccountMainInformationType

diagram

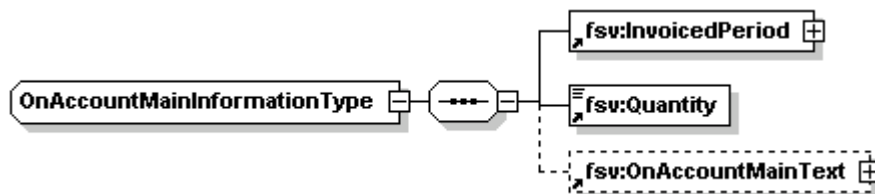

namespace <http://rep.oio.dk/ubl/xml/schemas/0p71/extensible/businessdomain/utilities/2005/10/11/>

children [fsv:InvoicedPeriod](#) [fsv:Quantity](#) [fsv:OnAccountMainText](#)

used by element [OnAccountMainInformation](#)

```

source <xsd:complexType name="OnAccountMainInformationType">
  <xsd:sequence>
    <xsd:element ref="fsv:InvoicedPeriod"/>
    <xsd:element ref="fsv:Quantity"/>
    <xsd:element ref="fsv:OnAccountMainText" minOccurs="0"/>
  </xsd:sequence>
</xsd:complexType>

```

### complexType OnAccountMainTextType

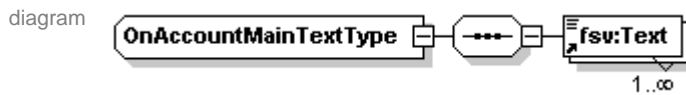

namespace <http://rep.oiio.dk/ubl/xml/schemas/0p71/extensible/businessdomain/utilities/2005/10/11/>

children [fsv:Text](#)

used by element [OnAccountMainText](#)

```

source <xsd:complexType name="OnAccountMainTextType">
  <xsd:sequence>
    <xsd:element ref="fsv:Text" maxOccurs="unbounded"/>
  </xsd:sequence>
</xsd:complexType>

```

### complexType OnAccountPaymentsTextType



namespace <http://rep.oiio.dk/ubl/xml/schemas/0p71/extensible/businessdomain/utilities/2005/10/11/>

children [fsv:Text](#)

used by element [OnAccountPaymentsText](#)

```

source <xsd:complexType name="OnAccountPaymentsTextType">
  <xsd:sequence>
    <xsd:element ref="fsv:Text" maxOccurs="unbounded"/>
  </xsd:sequence>
</xsd:complexType>

```

### complexType OnAccountPaymentsType

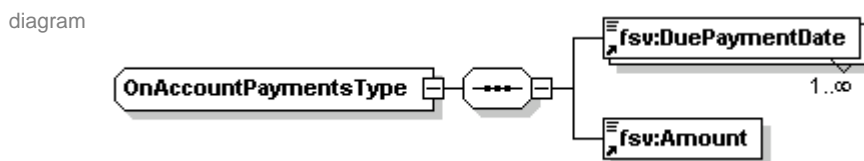

namespace <http://rep.oiio.dk/ubl/xml/schemas/0p71/extensible/businessdomain/utilities/2005/10/11/>

children [fsv:DuePaymentDate](#) [fsv:Amount](#)

used by element [OnAccountPayments](#)

```

source <xsd:complexType name="OnAccountPaymentsType">
  <xsd:sequence>
    <xsd:element ref="fsv:DuePaymentDate" maxOccurs="unbounded"/>
    <xsd:element ref="fsv:Amount"/>
  </xsd:sequence>
</xsd:complexType>

```



## complexType PartyIdentificationType

diagram

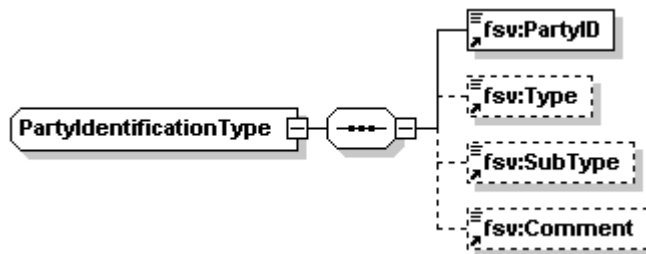

namespace <http://rep.oio.dk/ubl/xml/schemas/0p71/extensible/businessdomain/utilities/2005/10/11/>

children [fsv:PartyID](#) [fsv:Type](#) [fsv:SubType](#) [fsv:Comment](#)

used by element [PartyIdentification](#)

```
source <xsd:complexType name="PartyIdentificationType">
  <xsd:sequence>
    <xsd:element ref="fsv:PartyID"/>
    <xsd:element ref="fsv:Type" minOccurs="0"/>
    <xsd:element ref="fsv:SubType" minOccurs="0"/>
    <xsd:element ref="fsv:Comment" minOccurs="0"/>
  </xsd:sequence>
</xsd:complexType>
```

## complexType PartyNameType

diagram

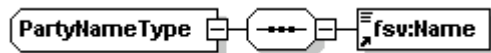

namespace <http://rep.oio.dk/ubl/xml/schemas/0p71/extensible/businessdomain/utilities/2005/10/11/>

children [fsv:Name](#)

used by element [PartyName](#)

```
source <xsd:complexType name="PartyNameType">
  <xsd:sequence>
    <xsd:element ref="fsv:Name"/>
  </xsd:sequence>
</xsd:complexType>
```

## complexType PeriodType

diagram

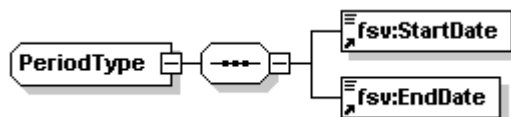

namespace <http://rep.oio.dk/ubl/xml/schemas/0p71/extensible/businessdomain/utilities/2005/10/11/>

children [fsv:StartDate](#) [fsv:EndDate](#)

used by element [Period](#)

```
source <xsd:complexType name="PeriodType">
  <xsd:sequence>
    <xsd:element ref="fsv:StartDate"/>
    <xsd:element ref="fsv:EndDate"/>
  </xsd:sequence>
</xsd:complexType>
```

## complexType QuantityType

diagram



namespace <http://rep.oio.dk/ubl/xml/schemas/0p71/extensible/businessdomain/utilities/2005/10/11/>

type extension of **xsd:decimal**

properties base **xsd:decimal**

used by elements [DeliveredQuantity](#) [InvoicedQuantity](#) [LatestMeterStand](#) [MeterConstant](#) [PackQuantity](#) [PreviousMeterStand](#) [Quantity](#) [TotalDeliveredQuantity](#)

attributes	Name	Type	Use	Default	Fixed	Annotation
	quantityUnitCode	<b>xsd:string</b>	required			

```
<xsd:complexType name="QuantityType">
  <xsd:simpleContent>
    <xsd:extension base="xsd:decimal">
      <xsd:attribute name="quantityUnitCode" type="xsd:string" use="required"/>
    </xsd:extension>
  </xsd:simpleContent>
</xsd:complexType>
```

## complexType ServiceChargeType

diagram

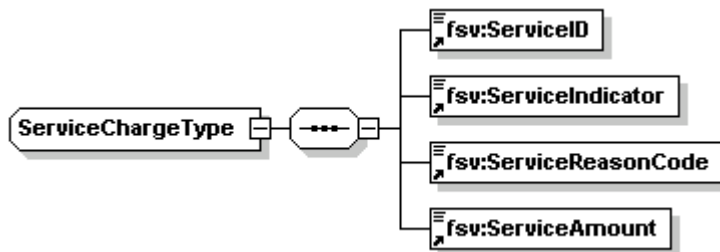

namespace <http://rep.oio.dk/ubl/xml/schemas/0p71/extensible/businessdomain/utilities/2005/10/11/>

children [fsv:ServiceID](#) [fsv:ServiceIndicator](#) [fsv:ServiceReasonCode](#) [fsv:ServiceAmount](#)

used by element [ServiceCharge](#)

```
<xsd:complexType name="ServiceChargeType">
  <xsd:sequence>
    <xsd:element ref="fsv:ServiceID"/>
    <xsd:element ref="fsv:ServiceIndicator"/>
    <xsd:element ref="fsv:ServiceReasonCode"/>
    <xsd:element ref="fsv:ServiceAmount"/>
  </xsd:sequence>
</xsd:complexType>
```

## complexType SupplierType

diagram

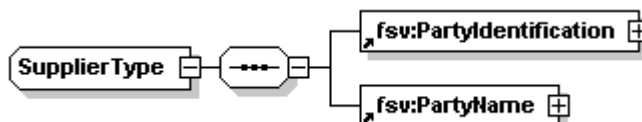

namespace <http://rep.oio.dk/ubl/xml/schemas/0p71/extensible/businessdomain/utilities/2005/10/11/>

children [fsv:PartyIdentification](#) [fsv:PartyName](#)

used by element [Supplier](#)

```

source <xsd:complexType name="SupplierType">
  <xsd:sequence>
    <xsd:element ref="fsv:PartyIdentification"/>
    <xsd:element ref="fsv:PartyName"/>
  </xsd:sequence>
</xsd:complexType>

```

### complexType TaxAmountsType

diagram

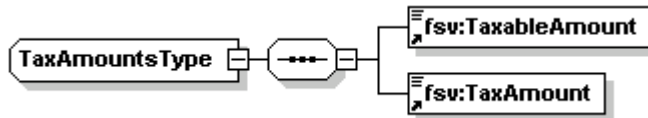

namespace <http://rep.oio.dk/ubl/xml/schemas/0p71/extensible/businessdomain/utilities/2005/10/11/>

children [fsv:TaxableAmount](#) [fsv:TaxAmount](#)

used by element [TaxAmounts](#)

```

source <xsd:complexType name="TaxAmountsType">
  <xsd:sequence>
    <xsd:element ref="fsv:TaxableAmount"/>
    <xsd:element ref="fsv:TaxAmount"/>
  </xsd:sequence>
</xsd:complexType>

```

### complexType TaxCategoryType

diagram

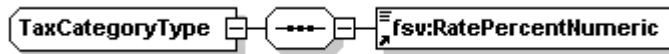

namespace <http://rep.oio.dk/ubl/xml/schemas/0p71/extensible/businessdomain/utilities/2005/10/11/>

children [fsv:RatePercentNumeric](#)

used by element [TaxCategory](#)

```

source <xsd:complexType name="TaxCategoryType">
  <xsd:sequence>
    <xsd:element ref="fsv:RatePercentNumeric"/>
  </xsd:sequence>
</xsd:complexType>

```

### complexType UtilityInvoiceMainPeriodType

diagram

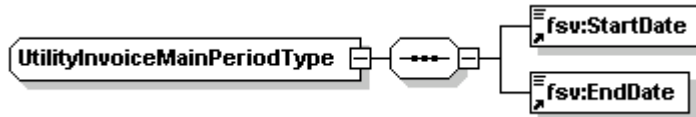

namespace <http://rep.oio.dk/ubl/xml/schemas/0p71/extensible/businessdomain/utilities/2005/10/11/>

children [fsv:StartDate](#) [fsv:EndDate](#)

used by element [UtilityInvoiceMainPeriod](#)

```

source <xsd:complexType name="UtilityInvoiceMainPeriodType">
  <xsd:sequence>
    <xsd:element ref="fsv:StartDate"/>
    <xsd:element ref="fsv:EndDate"/>
  </xsd:sequence>
</xsd:complexType>

```

## complexType UtilityInvoiceType

diagram

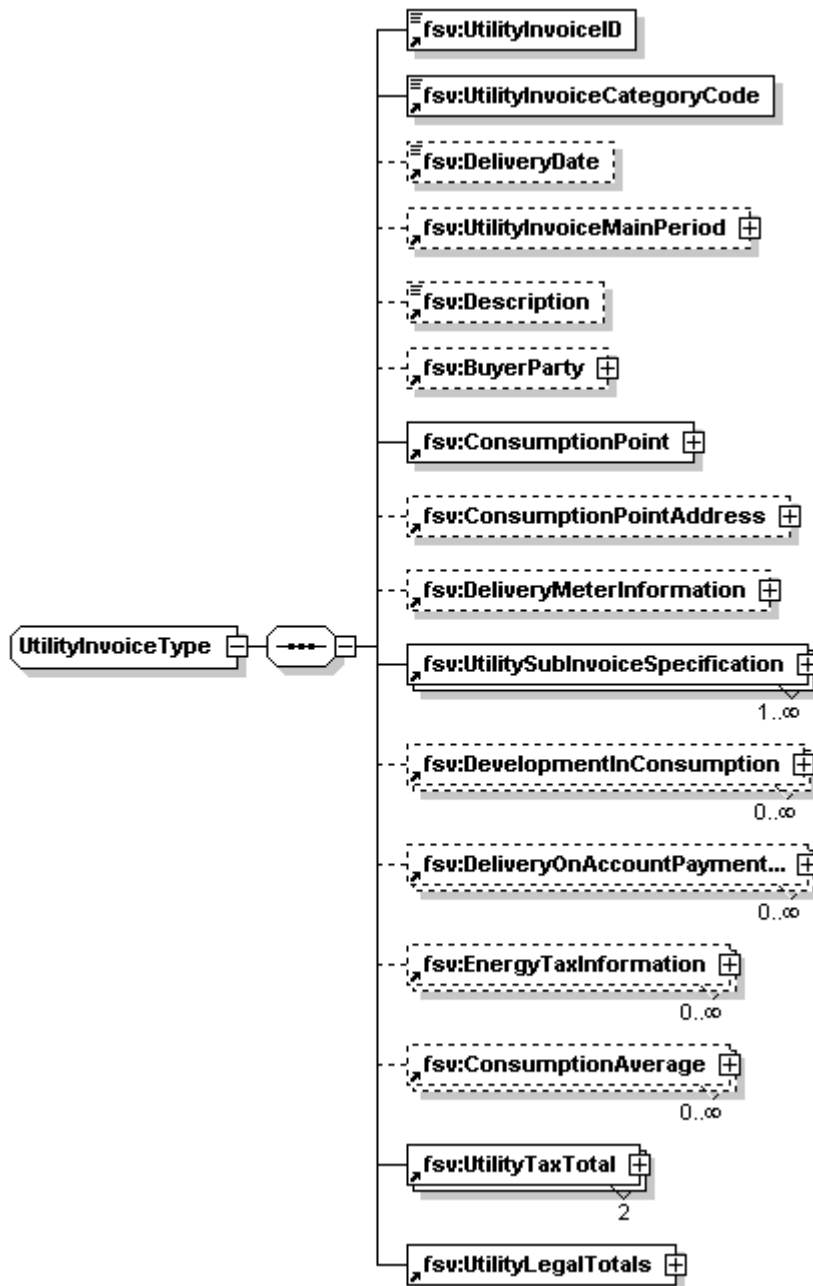

namespace <http://rep.oio.dk/ubl/xml/schemas/0p71/extensible/businessdomain/utilities/2005/10/11/>

children [fsv:UtilityInvoiceID](#) [fsv:UtilityInvoiceCategoryCode](#) [fsv:DeliveryDate](#) [fsv:UtilityInvoiceMainPeriod](#) [fsv:Description](#) [fsv:BuyerParty](#) [fsv:ConsumptionPoint](#) [fsv:ConsumptionPointAddress](#) [fsv:DeliveryMeterInformation](#) [fsv:UtilitySubInvoiceSpecification](#) [fsv:DevelopmentInConsumption](#) [fsv:DeliveryOnAccountPaymentSchedule](#) [fsv:EnergyTaxInformation](#) [fsv:ConsumptionAverage](#) [fsv:UtilityTaxTotal](#) [fsv:UtilityLegalTotals](#)

used by element [UtilityInvoice](#)

```

source <xsd:complexType name="UtilityInvoiceType">
  <xsd:sequence>
    <xsd:element ref="fsv:UtilityInvoiceID"/>
    <xsd:element ref="fsv:UtilityInvoiceCategoryCode"/>
    <xsd:element ref="fsv:DeliveryDate" minOccurs="0"/>
  
```

```

<xsd:element ref="fsv:UtilityInvoiceMainPeriod" minOccurs="0"/>
<xsd:element ref="fsv:Description" minOccurs="0"/>
<xsd:element ref="fsv:BuyerParty" minOccurs="0"/>
<xsd:element ref="fsv:ConsumptionPoint"/>
<xsd:element ref="fsv:ConsumptionPointAddress" minOccurs="0"/>
<xsd:element ref="fsv:DeliveryMeterInformation" minOccurs="0"/>
<xsd:element ref="fsv:UtilitySubInvoiceSpecification" maxOccurs="unbounded"/>
<xsd:element ref="fsv:DevelopmentInConsumption" minOccurs="0" maxOccurs="unbounded"/>
<xsd:element ref="fsv:DeliveryOnAccountPaymentSchedule" minOccurs="0" maxOccurs="unbounded"/>
<xsd:element ref="fsv:EnergyTaxInformation" minOccurs="0" maxOccurs="unbounded"/>
<xsd:element ref="fsv:ConsumptionAverage" minOccurs="0" maxOccurs="unbounded"/>
<xsd:element ref="fsv:UtilityTaxTotal" minOccurs="2" maxOccurs="2"/>
<xsd:element ref="fsv:UtilityLegalTotals"/>
</xsd:sequence>
</xsd:complexType>

```

## complexType UtilityLegalTotalsType

diagram

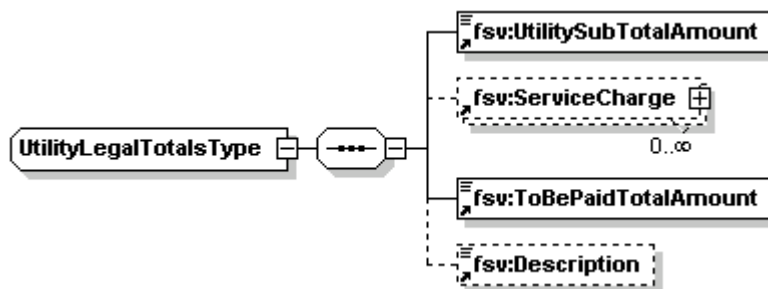

namespace <http://rep.oiio.dk/ubl/xml/schemas/0p71/extensible/businessdomain/utilities/2005/10/11/>

children [fsv:UtilitySubTotalAmount](#) [fsv:ServiceCharge](#) [fsv:ToBePaidTotalAmount](#) [fsv:Description](#)

used by element [UtilityLegalTotals](#)

```

source <xsd:complexType name="UtilityLegalTotalsType">
  <xsd:sequence>
    <xsd:element ref="fsv:UtilitySubTotalAmount"/>
    <xsd:element ref="fsv:ServiceCharge" minOccurs="0" maxOccurs="unbounded"/>
    <xsd:element ref="fsv:ToBePaidTotalAmount"/>
    <xsd:element ref="fsv:Description" minOccurs="0"/>
  </xsd:sequence>
</xsd:complexType>

```

## complexType UtilitySubInvoiceDetailsType

diagram

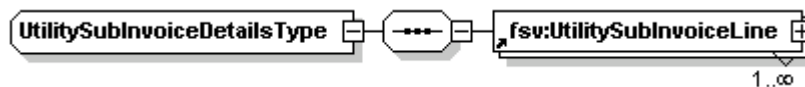

namespace <http://rep.oiio.dk/ubl/xml/schemas/0p71/extensible/businessdomain/utilities/2005/10/11/>

children [fsv:UtilitySubInvoiceLine](#)

used by element [UtilitySubInvoiceDetails](#)

```

source <xsd:complexType name="UtilitySubInvoiceDetailsType">
  <xsd:sequence>
    <xsd:element ref="fsv:UtilitySubInvoiceLine" maxOccurs="unbounded"/>
  </xsd:sequence>
</xsd:complexType>

```

## complexType UtilitySubInvoiceHeaderType

diagram

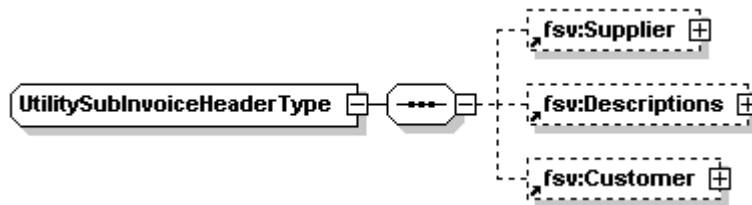

namespace <http://rep.oiio.dk/ubl/xml/schemas/0p71/extensible/businessdomain/utilities/2005/10/11/>

children [fsv:Supplier](#) [fsv:Descriptions](#) [fsv:Customer](#)

used by element [UtilitySubInvoiceHeader](#)

```
source <xsd:complexType name="UtilitySubInvoiceHeaderType">
  <xsd:sequence>
    <xsd:element ref="fsv:Supplier" minOccurs="0"/>
    <xsd:element ref="fsv:Descriptions" minOccurs="0"/>
    <xsd:element ref="fsv:Customer" minOccurs="0"/>
  </xsd:sequence>
</xsd:complexType>
```

## complexType UtilitySubInvoiceLineType

diagram

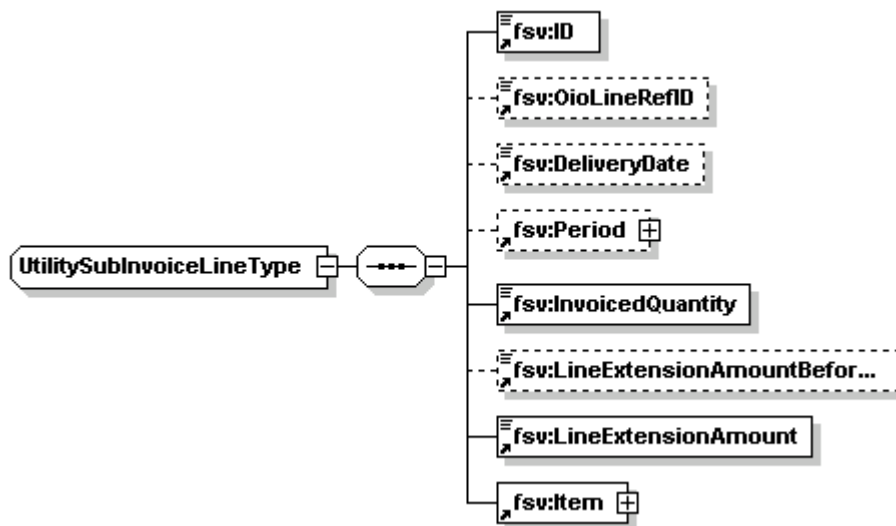

namespace <http://rep.oiio.dk/ubl/xml/schemas/0p71/extensible/businessdomain/utilities/2005/10/11/>

children [fsv:ID](#) [fsv:OioLineRefID](#) [fsv:DeliveryDate](#) [fsv:Period](#) [fsv:InvoicedQuantity](#) [fsv:LineExtensionAmountBeforeDiscount](#) [fsv:LineExtensionAmount](#) [fsv:Item](#)

used by element [UtilitySubInvoiceLine](#)

```
source <xsd:complexType name="UtilitySubInvoiceLineType">
  <xsd:sequence>
    <xsd:element ref="fsv:ID"/>
    <xsd:element ref="fsv:OioLineRefID" minOccurs="0"/>
    <xsd:element ref="fsv:DeliveryDate" minOccurs="0"/>
    <xsd:element ref="fsv:Period" minOccurs="0"/>
    <xsd:element ref="fsv:InvoicedQuantity"/>
    <xsd:element ref="fsv:LineExtensionAmountBeforeDiscount" minOccurs="0"/>
    <xsd:element ref="fsv:LineExtensionAmount"/>
    <xsd:element ref="fsv:Item"/>
  </xsd:sequence>
</xsd:complexType>
```

## complexType UtilitySubInvoiceSpecificationType

diagram

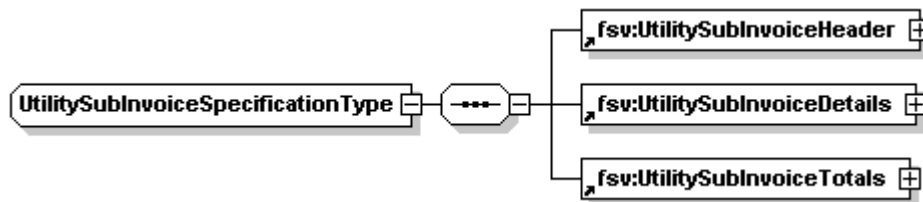

namespace <http://rep.oiio.dk/ubl/xml/schemas/0p71/extensible/businessdomain/utilities/2005/10/11/>

children [fsv:UtilitySubInvoiceHeader](#) [fsv:UtilitySubInvoiceDetails](#) [fsv:UtilitySubInvoiceTotals](#)

used by element [UtilitySubInvoiceSpecification](#)

```
<xsd:complexType name="UtilitySubInvoiceSpecificationType">
  <xsd:sequence>
    <xsd:element ref="fsv:UtilitySubInvoiceHeader"/>
    <xsd:element ref="fsv:UtilitySubInvoiceDetails"/>
    <xsd:element ref="fsv:UtilitySubInvoiceTotals"/>
  </xsd:sequence>
</xsd:complexType>
```

## complexType UtilitySubInvoiceTotalsType

diagram

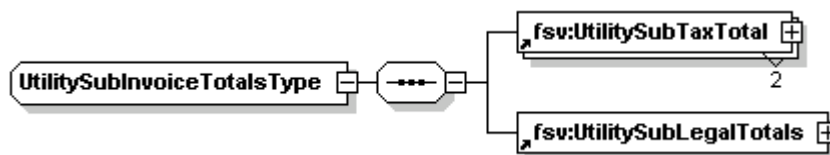

namespace <http://rep.oiio.dk/ubl/xml/schemas/0p71/extensible/businessdomain/utilities/2005/10/11/>

children [fsv:UtilitySubTaxTotal](#) [fsv:UtilitySubLegalTotals](#)

used by element [UtilitySubInvoiceTotals](#)

```
<xsd:complexType name="UtilitySubInvoiceTotalsType">
  <xsd:sequence>
    <xsd:element ref="fsv:UtilitySubTaxTotal" minOccurs="2" maxOccurs="2"/>
    <xsd:element ref="fsv:UtilitySubLegalTotals"/>
  </xsd:sequence>
</xsd:complexType>
```

## complexType UtilitySubLegalTotalsType

diagram

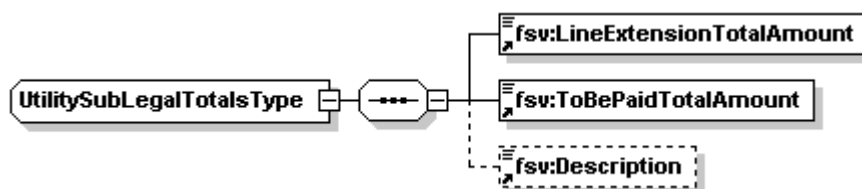

namespace <http://rep.oiio.dk/ubl/xml/schemas/0p71/extensible/businessdomain/utilities/2005/10/11/>

children [fsv:LineExtensionTotalAmount](#) [fsv:ToBePaidTotalAmount](#) [fsv:Description](#)

used by element [UtilitySubLegalTotals](#)

```
<xsd:complexType name="UtilitySubLegalTotalsType">
  <xsd:sequence>
    <xsd:element ref="fsv:LineExtensionTotalAmount"/>
  </xsd:sequence>
</xsd:complexType>
```

```

<xsd:element ref="fsv:ToBePaidTotalAmount"/>
<xsd:element ref="fsv:Description" minOccurs="0"/>
</xsd:sequence>
</xsd:complexType>

```

## complexType UtilitySubTaxTotalType

diagram

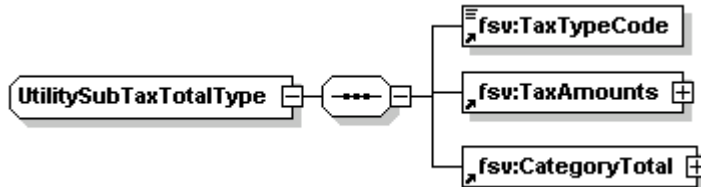

namespace <http://rep.oio.dk/ubl/xml/schemas/0p71/extensible/businessdomain/utilities/2005/10/11/>

children [fsv:TaxTypeCode](#) [fsv:TaxAmounts](#) [fsv:CategoryTotal](#)

used by element [UtilitySubTaxTotal](#)

```

source <xsd:complexType name="UtilitySubTaxTotalType">
  <xsd:sequence>
    <xsd:element ref="fsv:TaxTypeCode"/>
    <xsd:element ref="fsv:TaxAmounts"/>
    <xsd:element ref="fsv:CategoryTotal"/>
  </xsd:sequence>
</xsd:complexType>

```

## complexType UtilityTaxTotalType

diagram

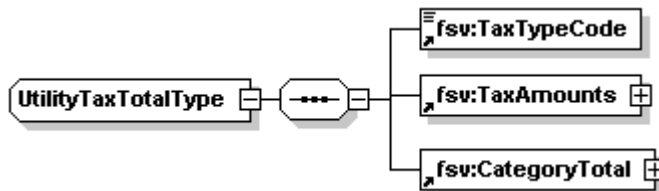

namespace <http://rep.oio.dk/ubl/xml/schemas/0p71/extensible/businessdomain/utilities/2005/10/11/>

children [fsv:TaxTypeCode](#) [fsv:TaxAmounts](#) [fsv:CategoryTotal](#)

used by element [UtilityTaxTotal](#)

```

source <xsd:complexType name="UtilityTaxTotalType">
  <xsd:sequence>
    <xsd:element ref="fsv:TaxTypeCode"/>
    <xsd:element ref="fsv:TaxAmounts"/>
    <xsd:element ref="fsv:CategoryTotal"/>
  </xsd:sequence>
</xsd:complexType>

```